

User Manual

APPC-7XPL/N



PRO DVX | ALWAYS ON

Content

- Declaration 3
- Product Instruction 3
- Insert SD Card 4
- Insert USB Devices..... 4
- Home Screen..... 5
- System Bar 8
- Applications 10
- Language..... 12
- Date & Time..... 13
- Volume 14
- Brightness 14
- Scheduled Sleep On/Off..... 15
- Wi-Fi..... 19
- Ethernet 20
- Bluetooth 21
- Virtual Keyboard..... 24
- Switch Input Methods..... 25
- Surf Online 26
- Browse Files 27
- Play Media..... 28
- Install & Uninstall Apps 29
 - Install Apps..... 29
 - Uninstall Apps 32
- Reset to Factory Default..... 34
- Federal Communications Commission (FCC) Statement 36

Declaration

- ✓ Please read the instructions carefully before equipment installation and using the device.
- ✓ Do not put the product in high temperature, humid or dusty environment.
- ✓ Do not drop, crash or break down this product.
- ✓ Do not power off the device when it's formatting or upgrading, otherwise it will cause operation system error.
- ✓ This product is not waterproof.
- ✓ Use only approved add-on enhancements.

Product Instruction

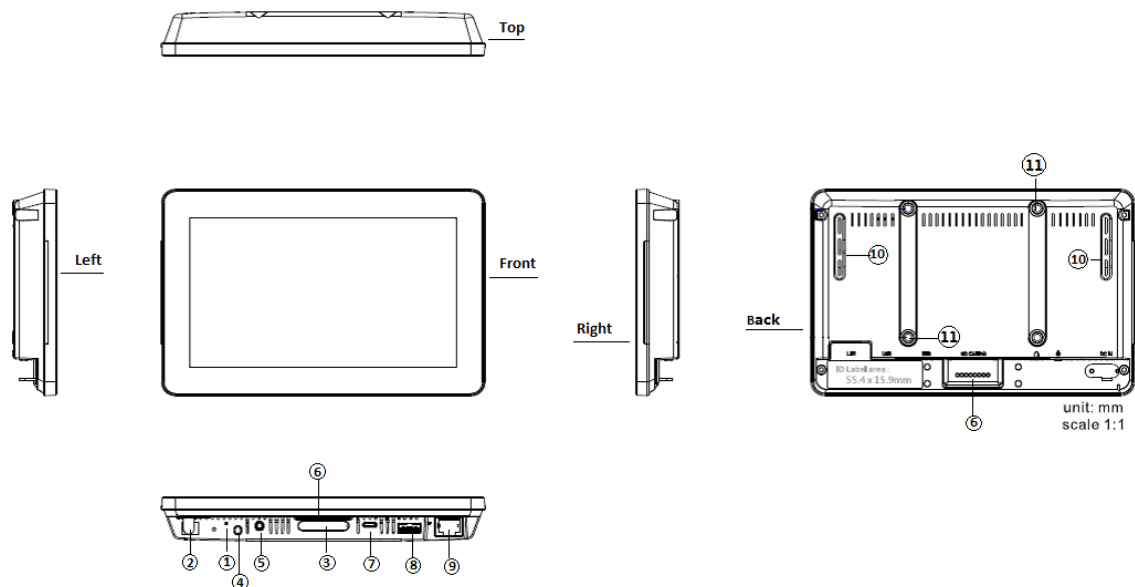

1. LED Indicator:

Red	System is booting.
Green	System is working properly.
Light Off	Power supply is off.

2. DC In Jack: powered by 12V/2A DC input

3. SD Card Slot / Cover: support external SD card

4. Power Key: (1).Short press sleep and wake up

(2).Long press to pop out the power off and reboot dialog box

5. Headset + Microphone Jack

6. Add-on module slot: to put optional add-on module

- 7. Micro-USB Port:** support USB 2.0 high speed 480Mbps
- 8. USB Port:** support USB 2.0 high speed 480Mbps
- 9. Ethernet RJ45 Port:** support Ethernet connection (10/100Mbps LAN)
- 10. Speaker:** audio output
- 11. VESA Mount Holes:** for installing the bracket
- 12. WIFI:** 802.11b/g/n/ac 2.4G/5G
- 13. Temperature:** Operation: 0°C ~ 40°C (32F ~104F)
Storage: -10°C ~ 55°C (14°F ~ 131°F)

Insert SD Card

This product supports external SD card. Please insert your SD card into the SD Card Slot (#3 in [Product Instruction](#)) on the top of this product.

Insert USB Devices

This product supports USB and Micro-USB to deal with your files.

USB

Plug your USB memory into the USB port (#8 in [Product Instruction](#)) on the bottom of this product, and then you can do the file operations via the File Browser. (See the details in [Browse Files](#)).

Micro-USB

Connect the Micro-USB port (#7 in [Product Instruction](#)) on the bottom of this product and the USB port on your computer with a Micro-USB-to-USB cable.

In the "USB Debug Connection" window that automatically pops up, click the "USB Preferences" button and select "File Transfer" to make the device visible on your computer.

Home Screen

In the home screen, you can long-press the blank space to change the wallpaper or drag widgets to desktop.

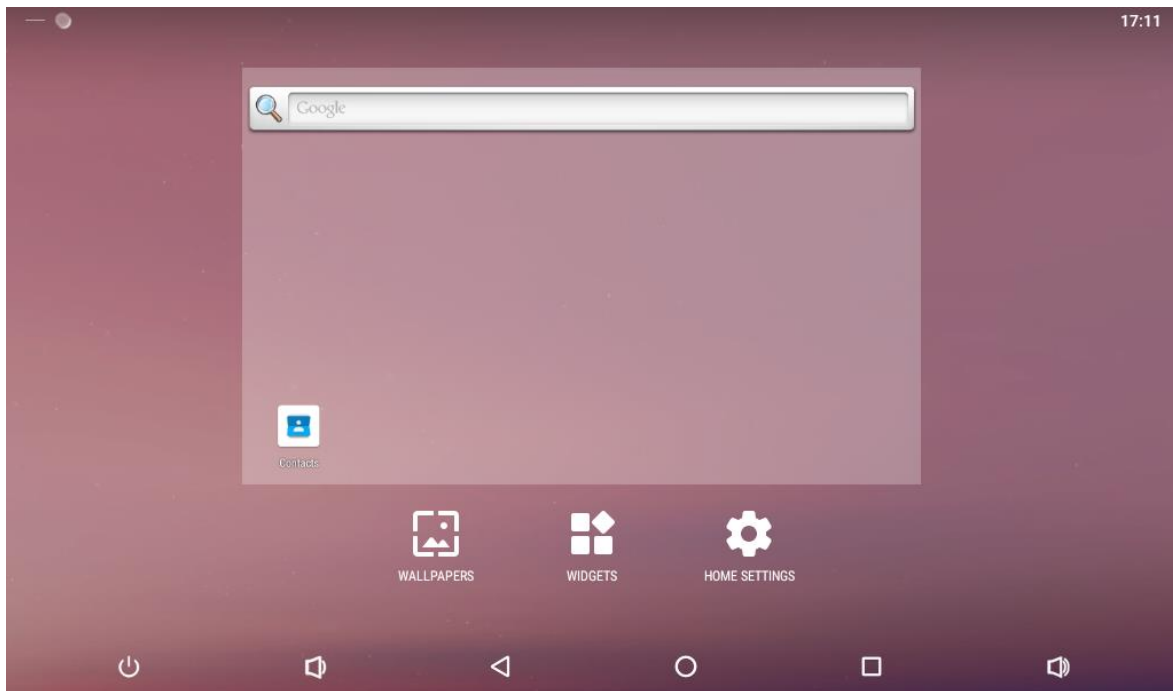

Change Wallpaper:

1. Click "Wallpapers".

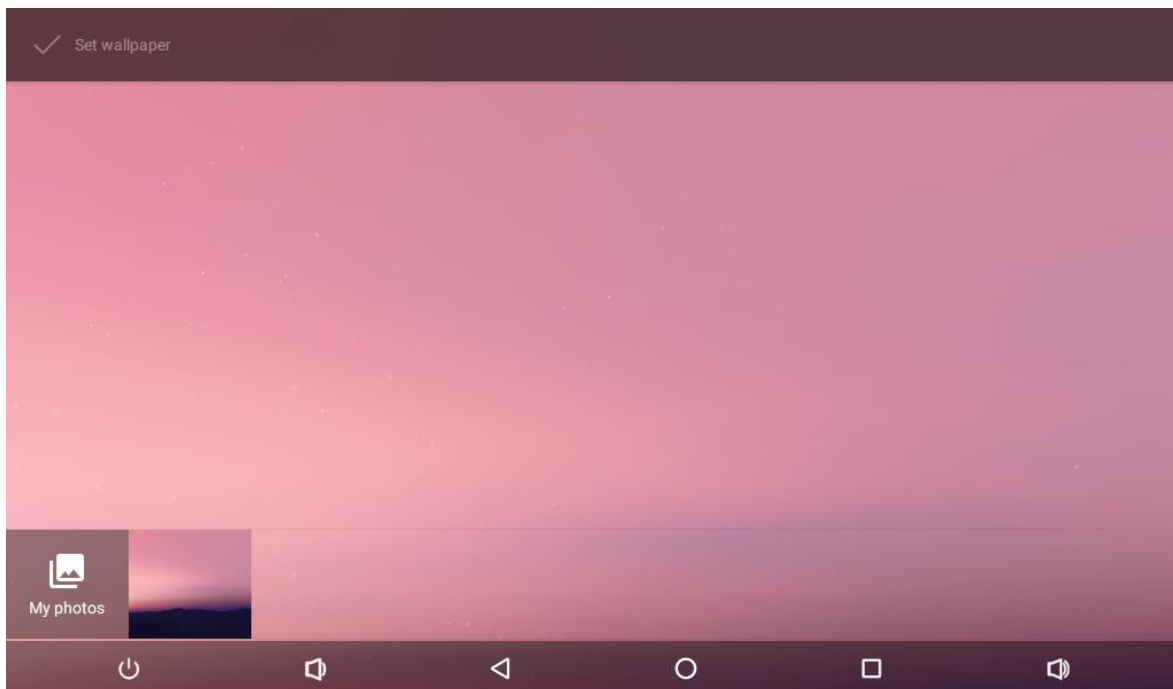

2. Select an image from the Myphotos preset.

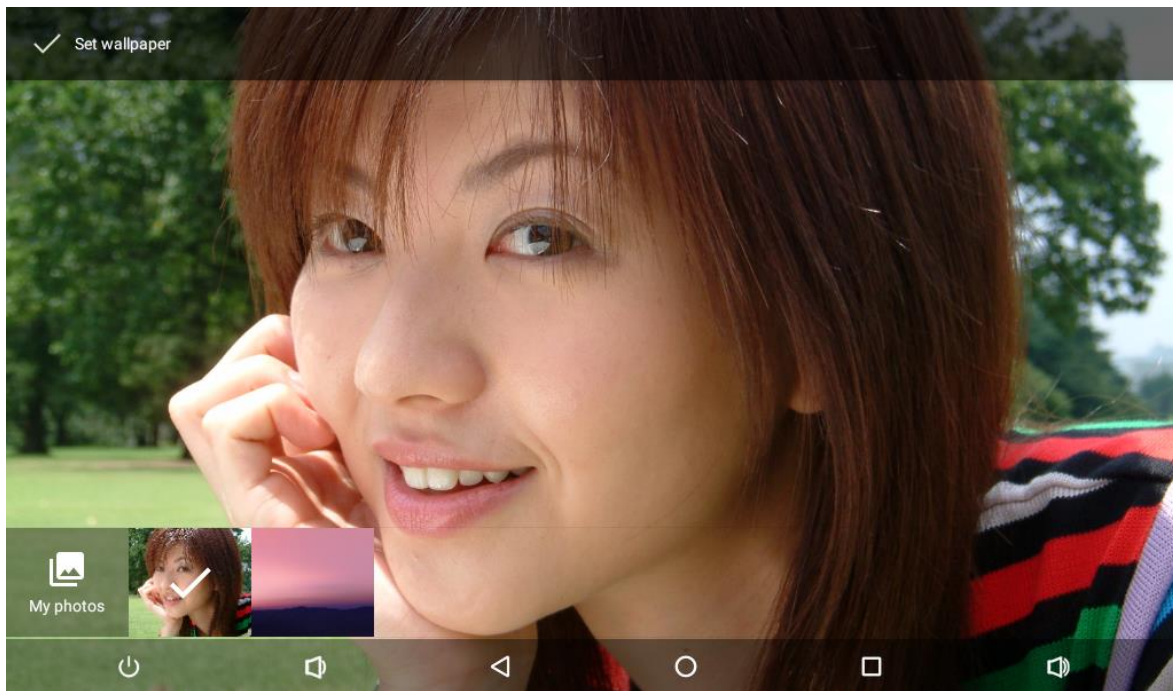

3. Click “Set wallpaper” on the upper-left corner of the screen to apply the wallpaper.

Add Widgets:

1. Click “Widgets”.

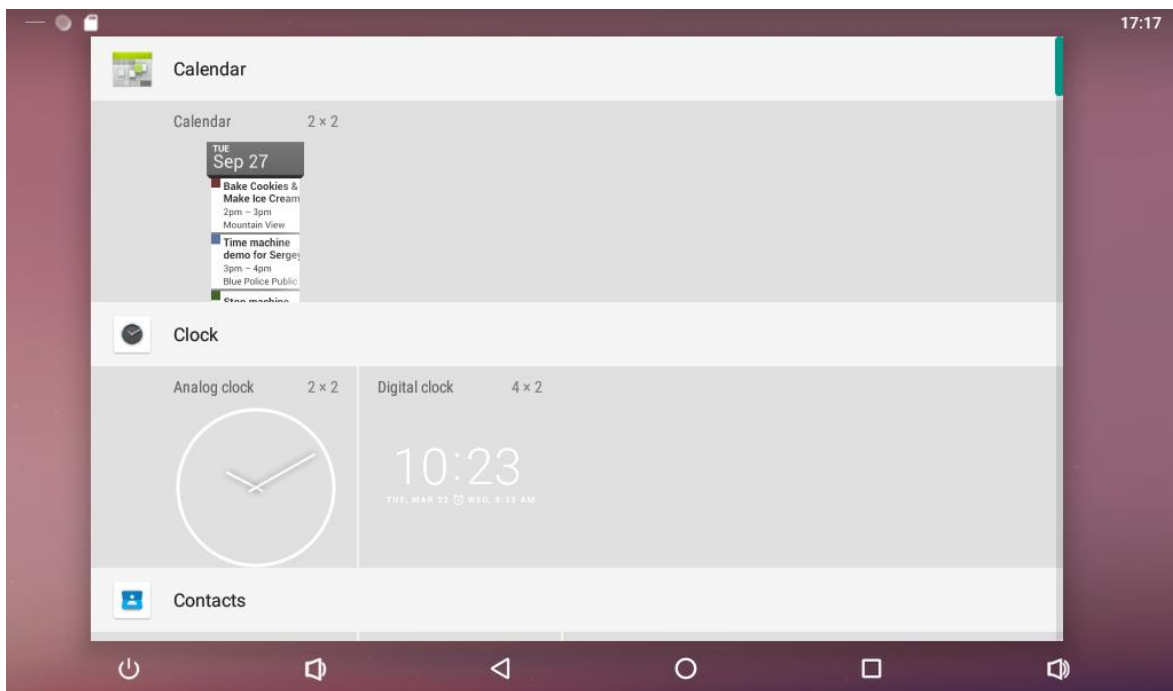

2. Long-press a widget and drag it to desktop.

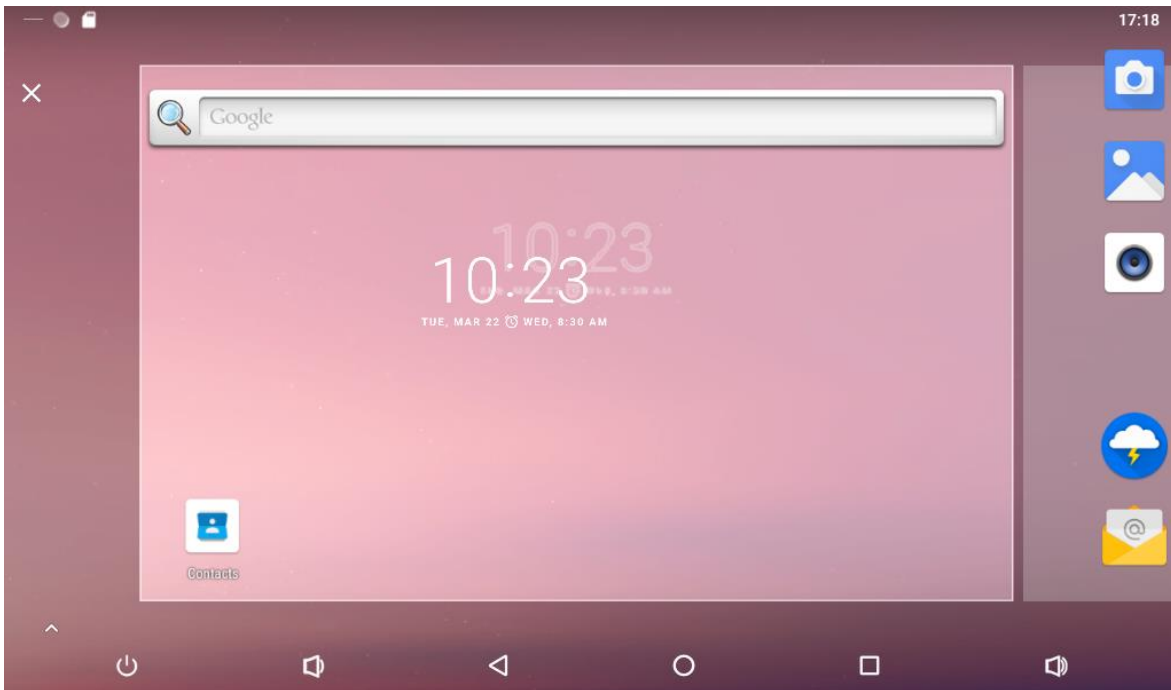

3. If you want to remove an icon, long press the widget and drag it to the top left corner of the screen, "x".

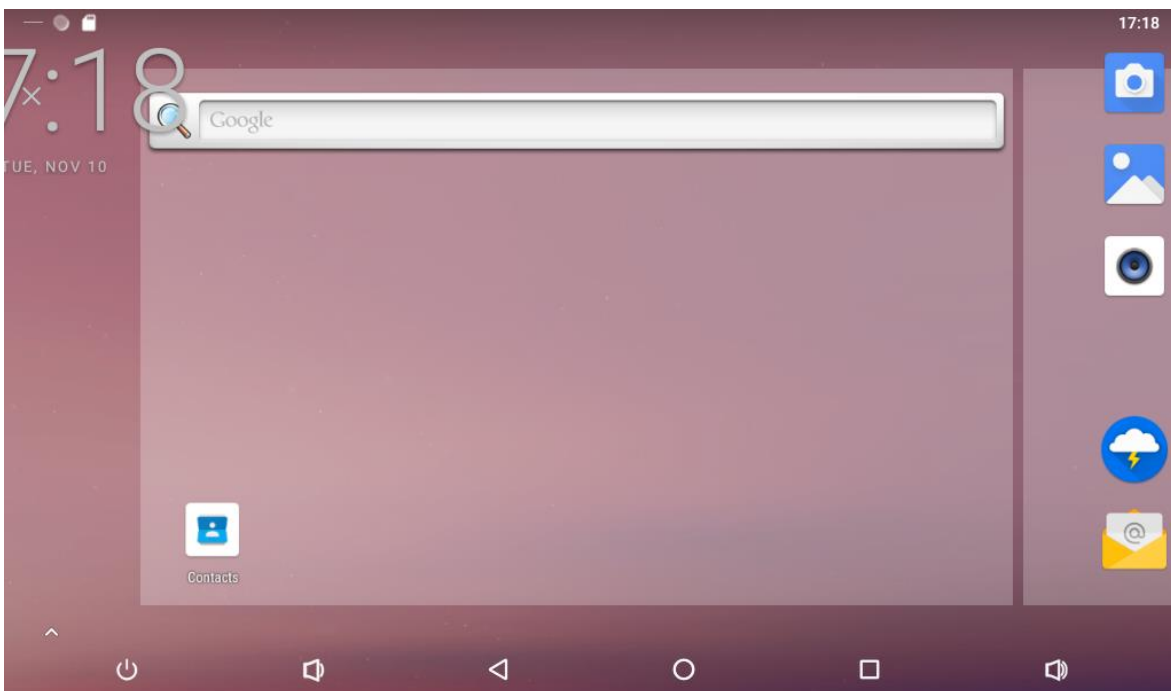

System Bar

Navigation Buttons



- 1. Power:** Power off and restart.
- 2. Volume-:** Decrease the system volume.
- 3. Back:** Return to the previous page.
- 4. Home:** Return to the home screen.
- 5. Recents:** Switch between recently used apps.

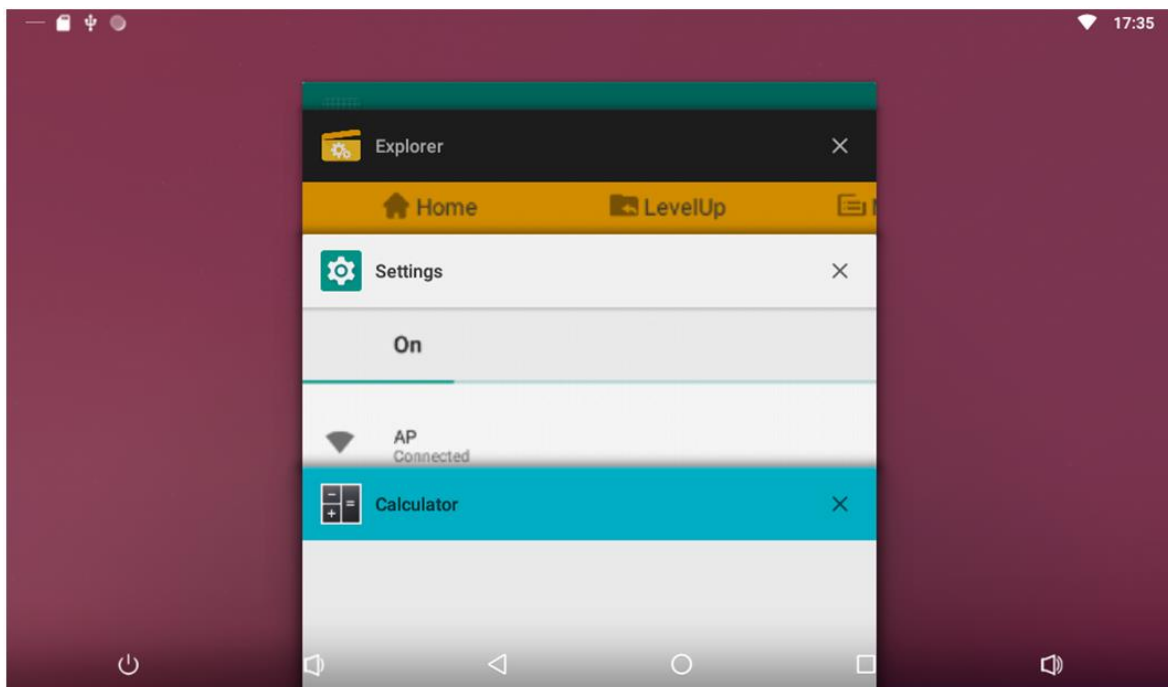

To remove an application from the list, swipe left or right to remove the list.

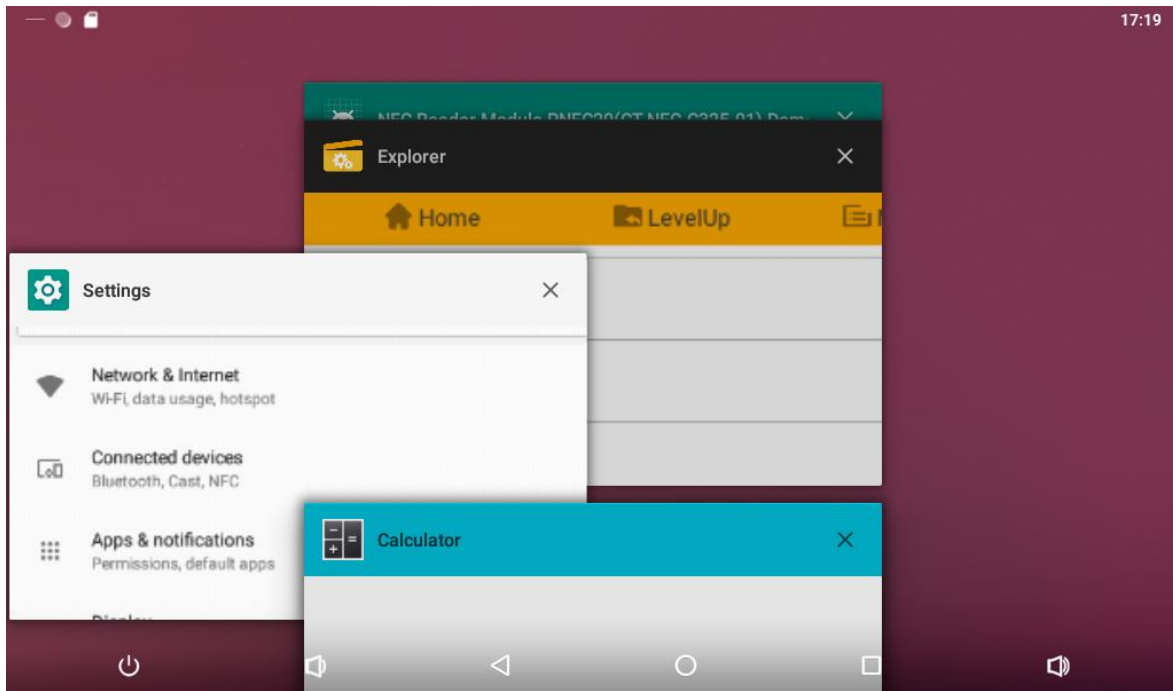

6. Volume+: Increase the system volume.

Status Notifications



Status bar at top of the screen displays system status, such as time, Wi-Fi, SD card and USB connection etc.

Pull down from the top to open the status window.

Includes brightness adjustment, Wi-Fi, automatic rotation, flight mode and position switching, system setting entry.

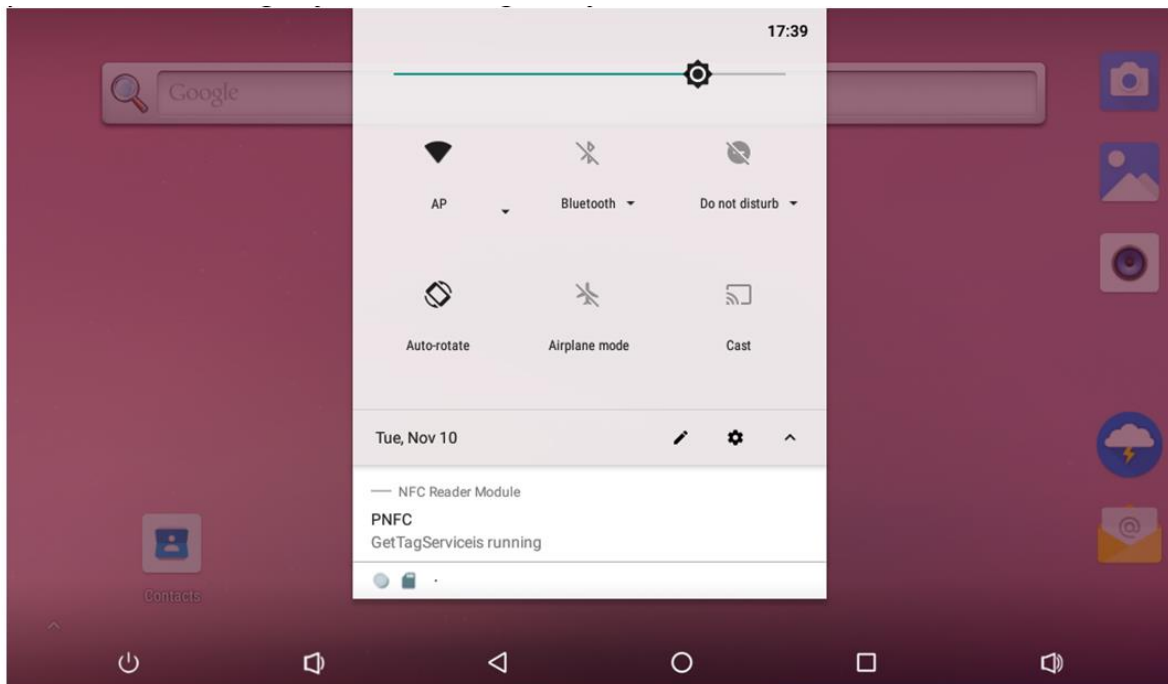

Applications

Slide the page up at the bottom of home screen to enter the applications page.

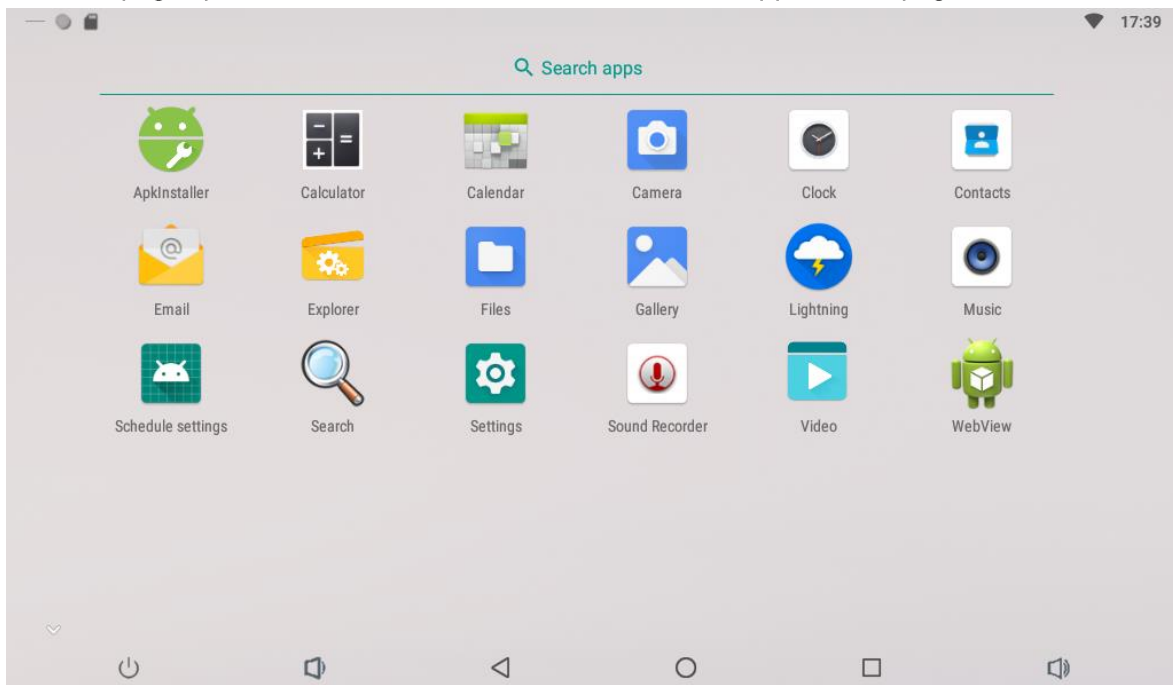

The installed applications will be shown here and you can open an app by clicking its icon.

To find an app easily, you can create a shortcut by long-pressing of the icon and drag it to the home screen.

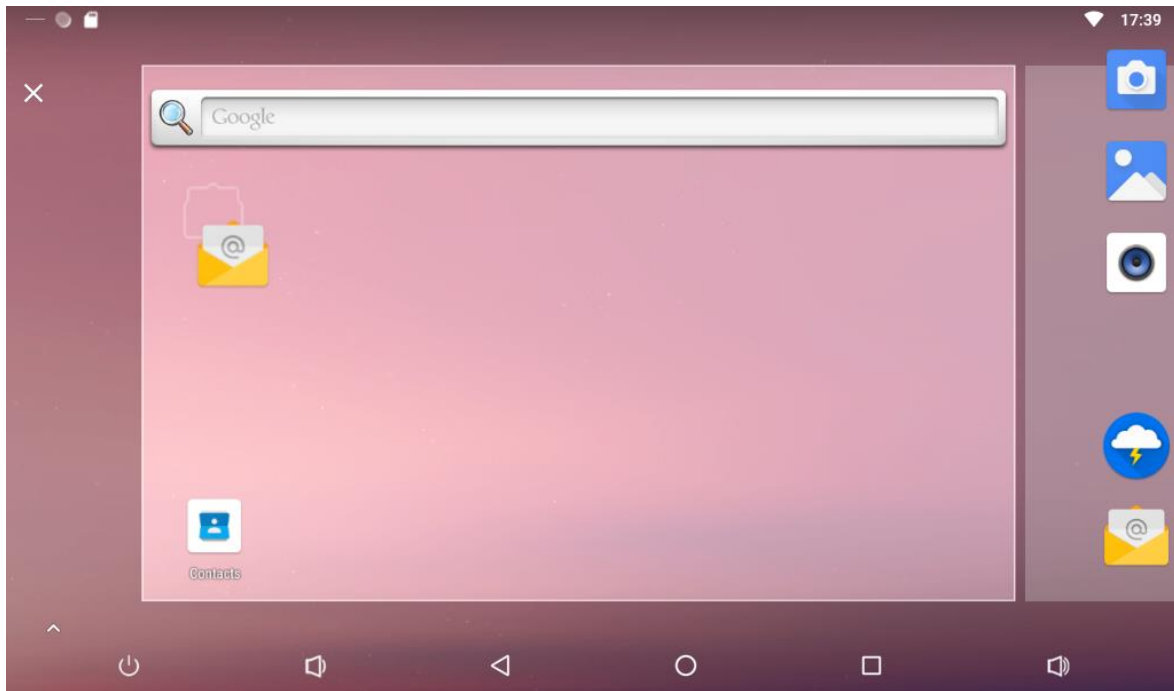

Language

In the App list, click “**Settings**”  to open the system setting app, and select the option ”System”→ “**Language & input**”.

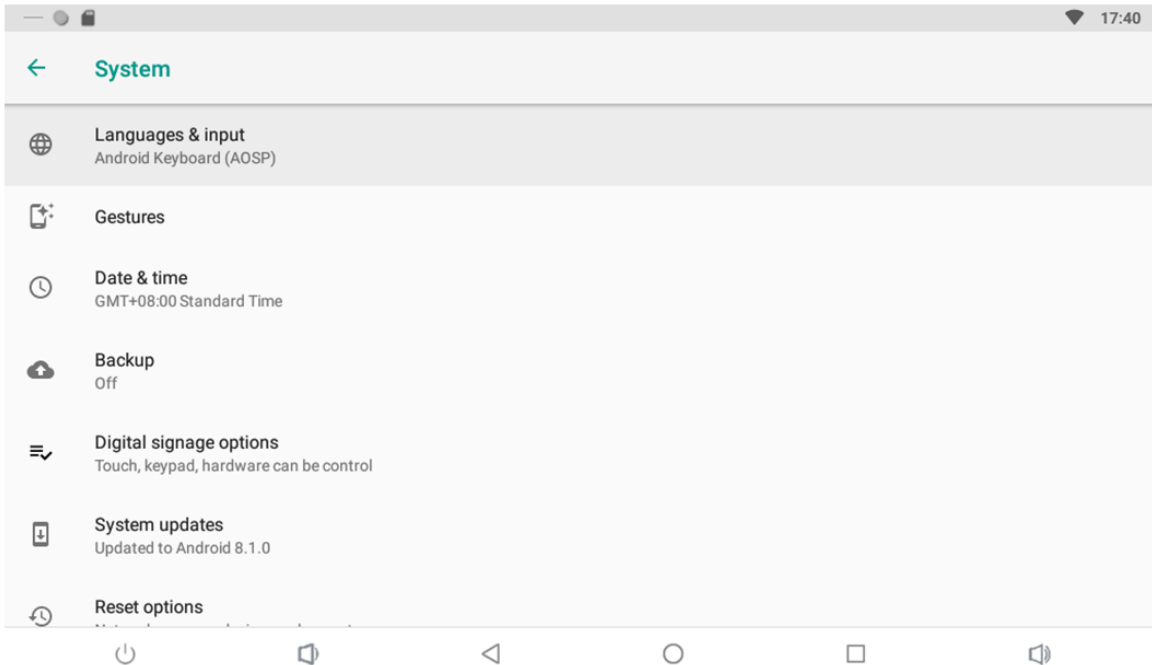

Click the first option “**Language**” under “**Language & input**”, and then you can change the system language according to your preference.

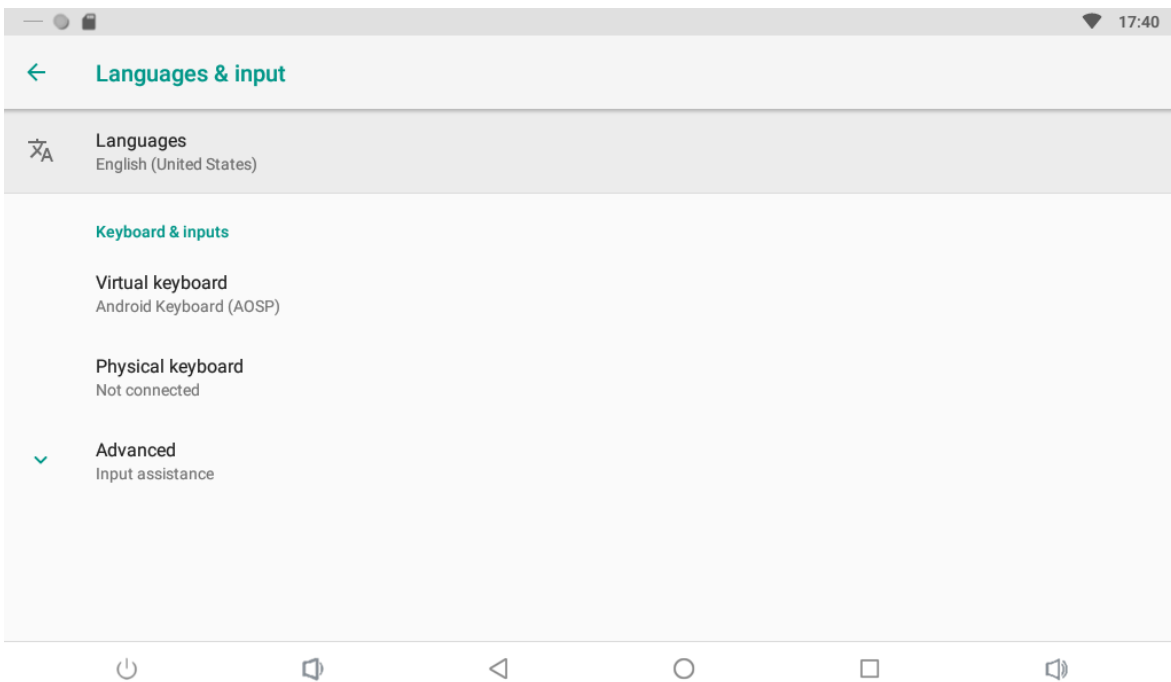

Date & Time

In the App list, click “**Settings**”  to open the system setting app, and select the option “**Date & time**”.

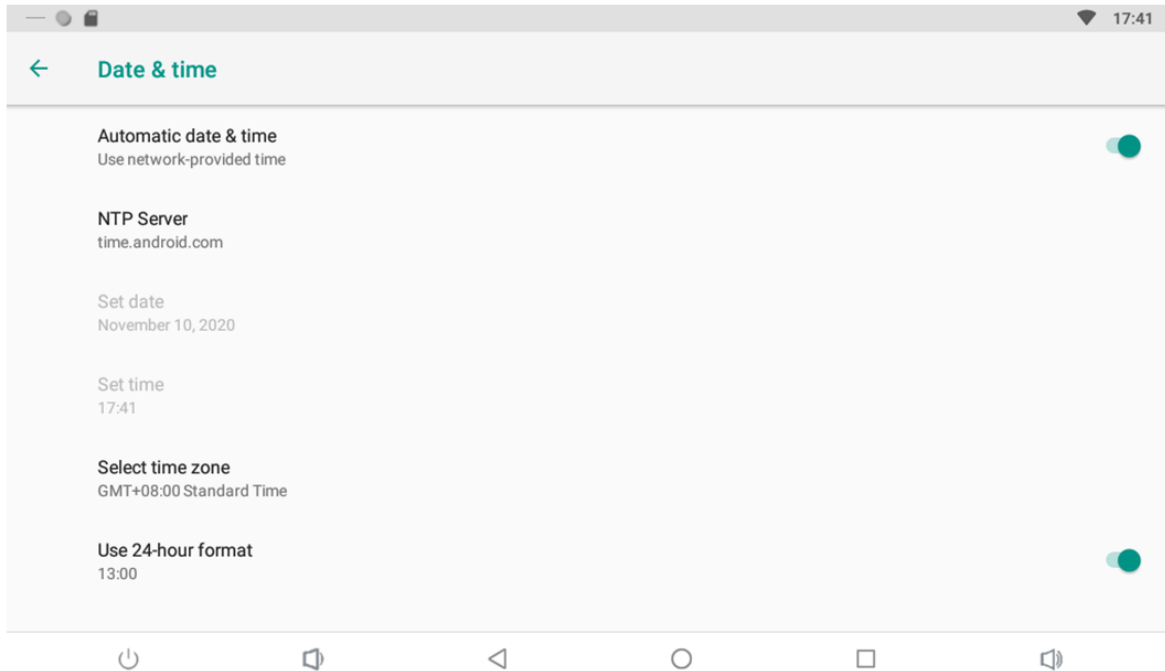

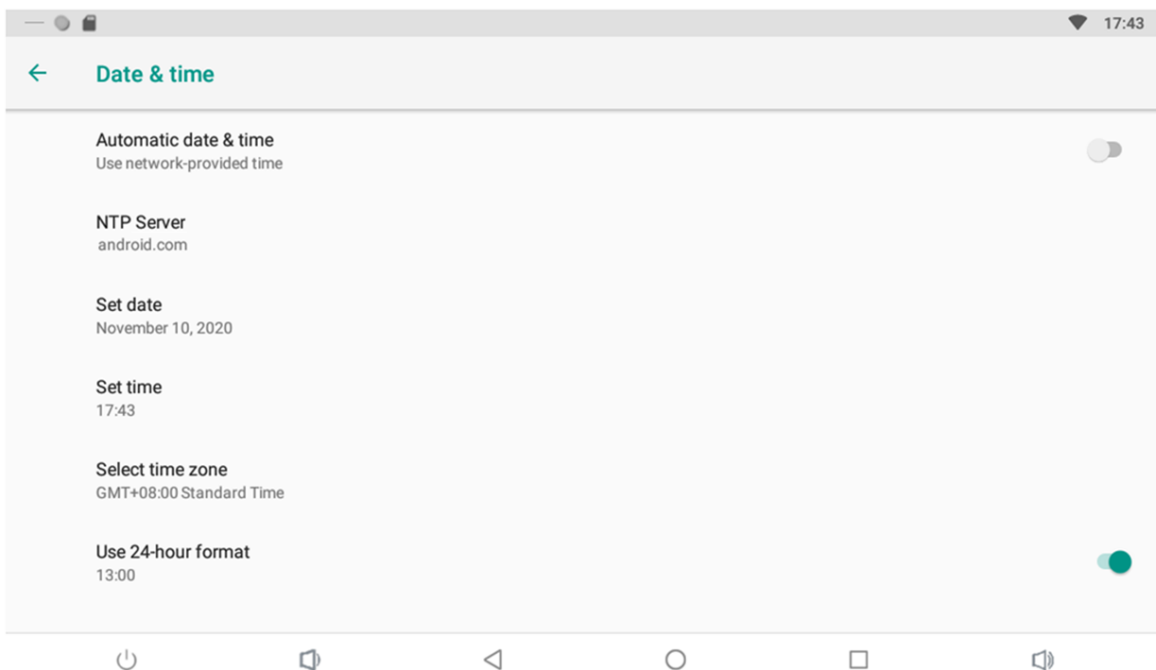

If you enabled the option “**Automatic date & time**” under “**Date & time**”, system date and time will be synchronized automatically with network time when you connected a Wi-Fi network.

If you want to set the time manually, you need to disable “**Automatic date & time**”.



In this option, you can also set time zone, time notation and date format.

Volume

On the system bar, click the **Volume-** icon  to decrease the system volume, and click the **Volume+** icon  to increase the system volume

Brightness

Pull down the screen to open the shortcuts window, and then click “Brightness”.

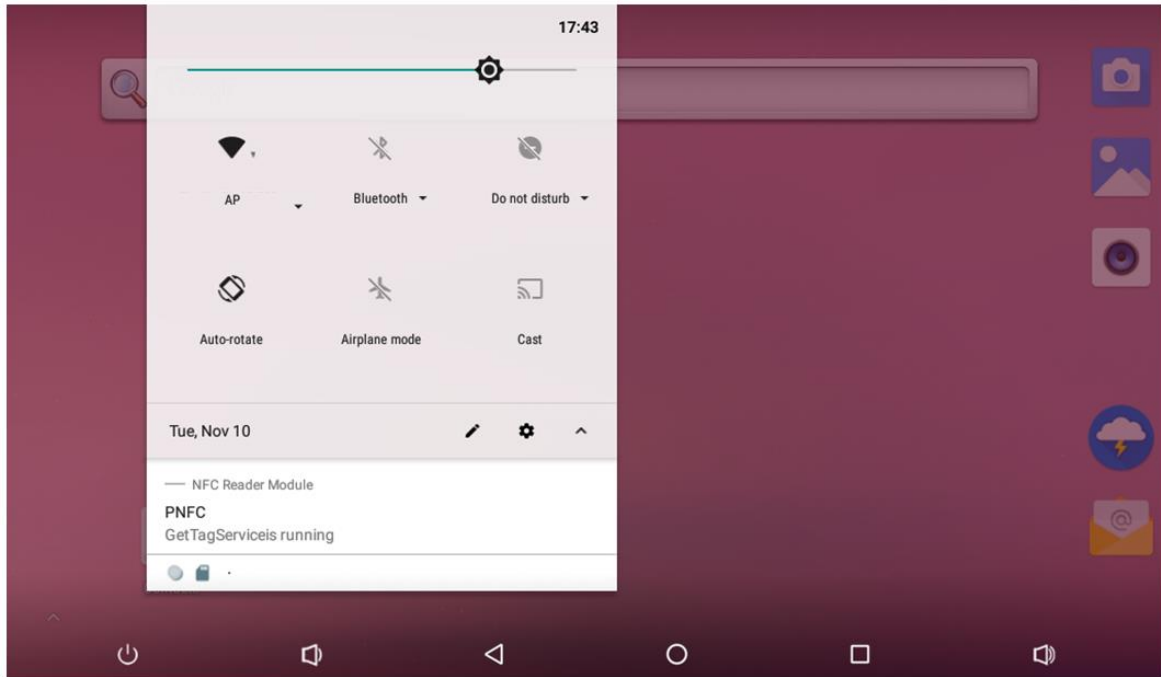

Slide the brightness button to adjust the brightness of the screen, or turn on Auto switch to automatically adjust the display's brightness to the appropriate level for the current ambient light.



Scheduled Sleep On/Off

This function is used to power the device on and off automatically at the set time.

In the App list, click “**Settings**”  to open the system setting app, and select the option “Digital signage options” → “**Schedule**”.

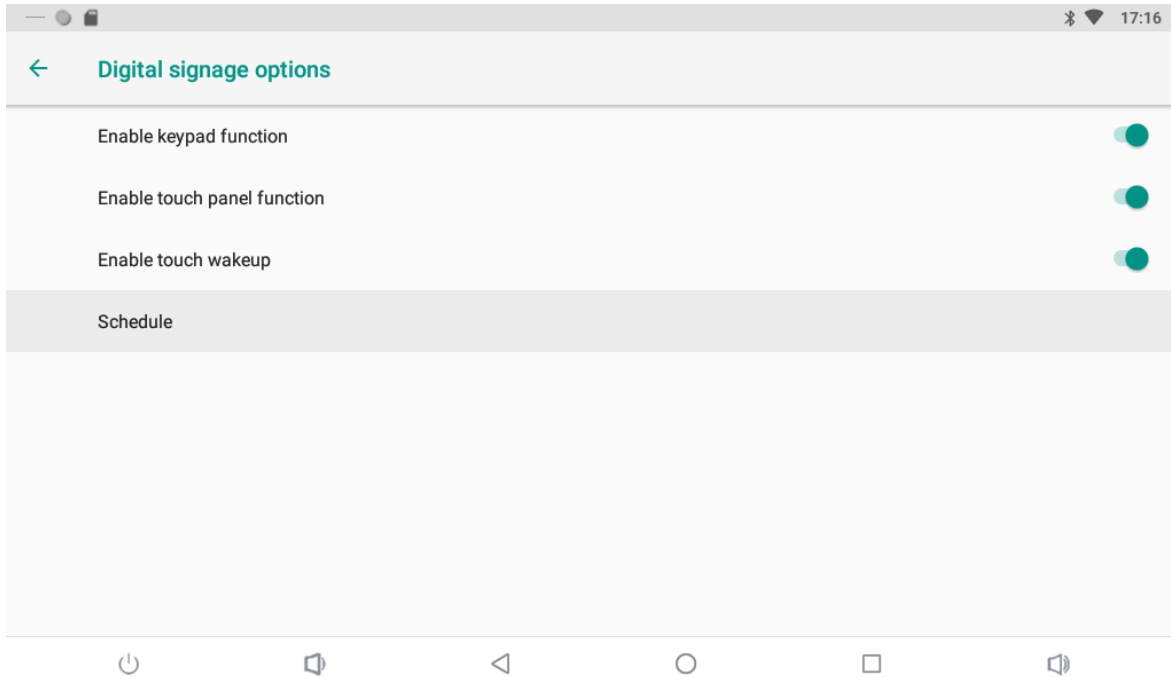

Click the single option “**Set Scheduled sleep On/Off Clocks**”.

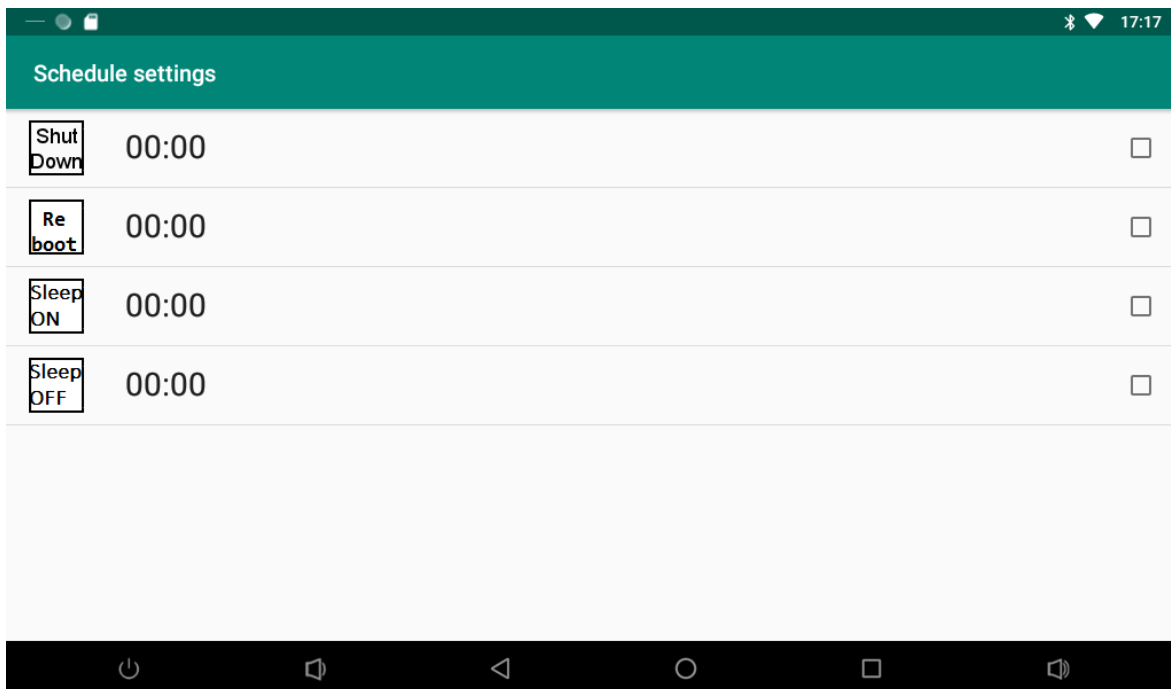

Sleep ON: Enter sleep.

Sleep OFF: Wake up.

Click “Set Sleep ON Clock”.

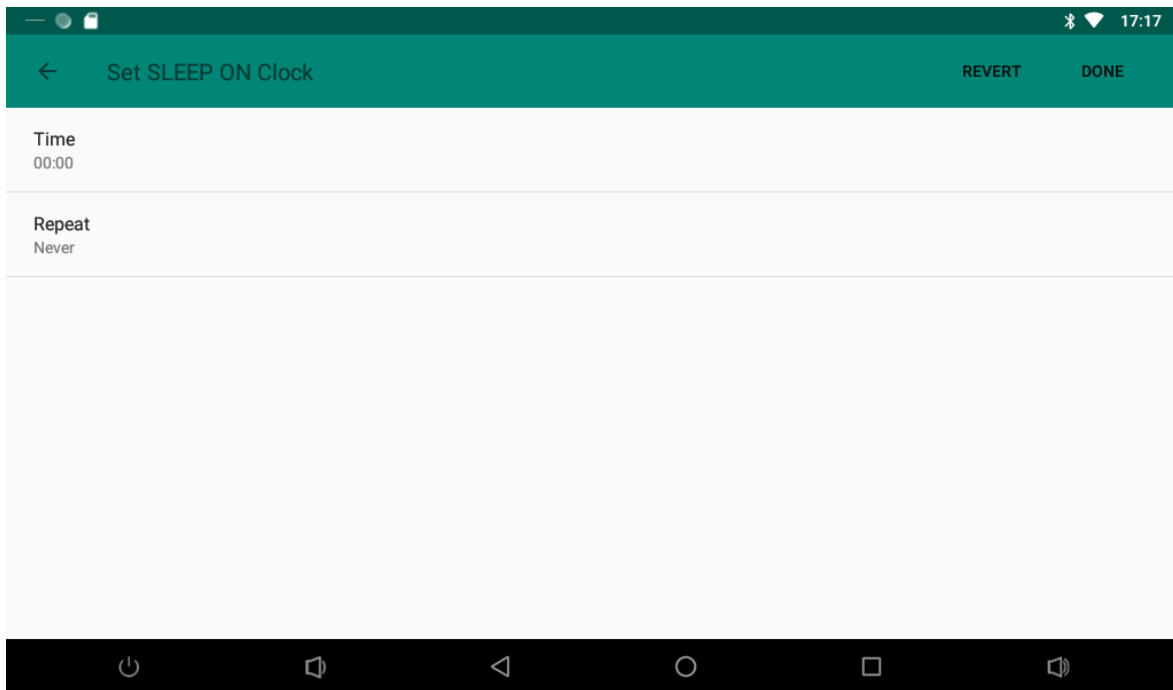

Click the option “Time” to set the sleep on time of this device.

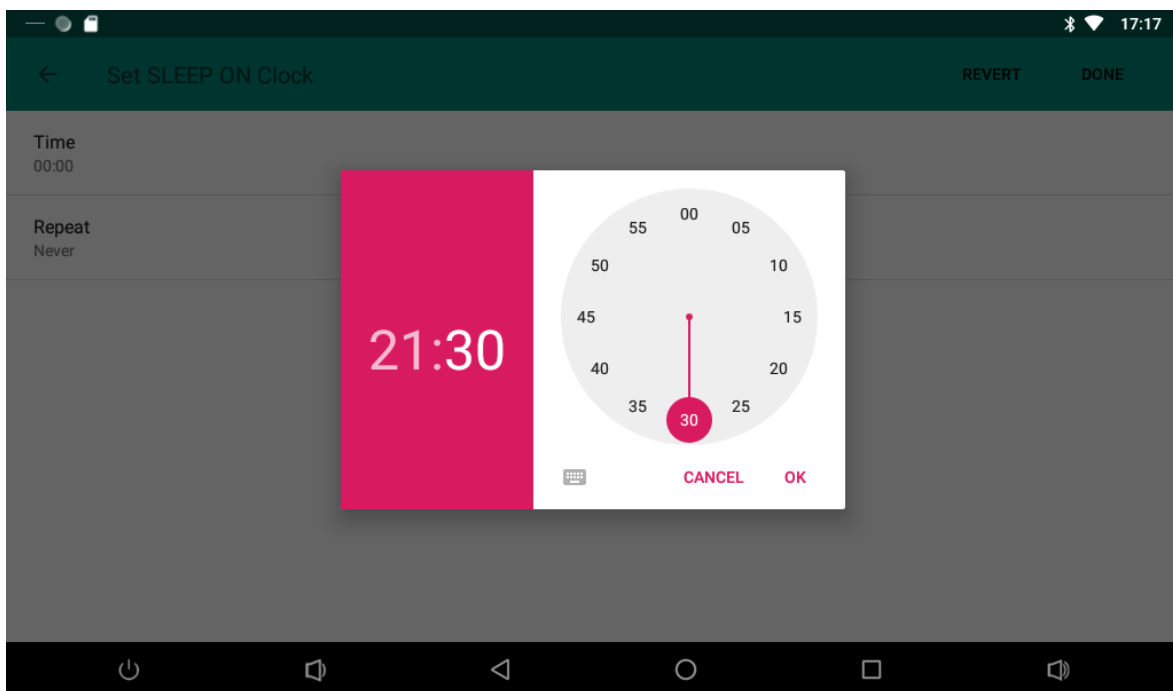

Click the option “Repeat” to select the days which will sleep on this device at the set time.

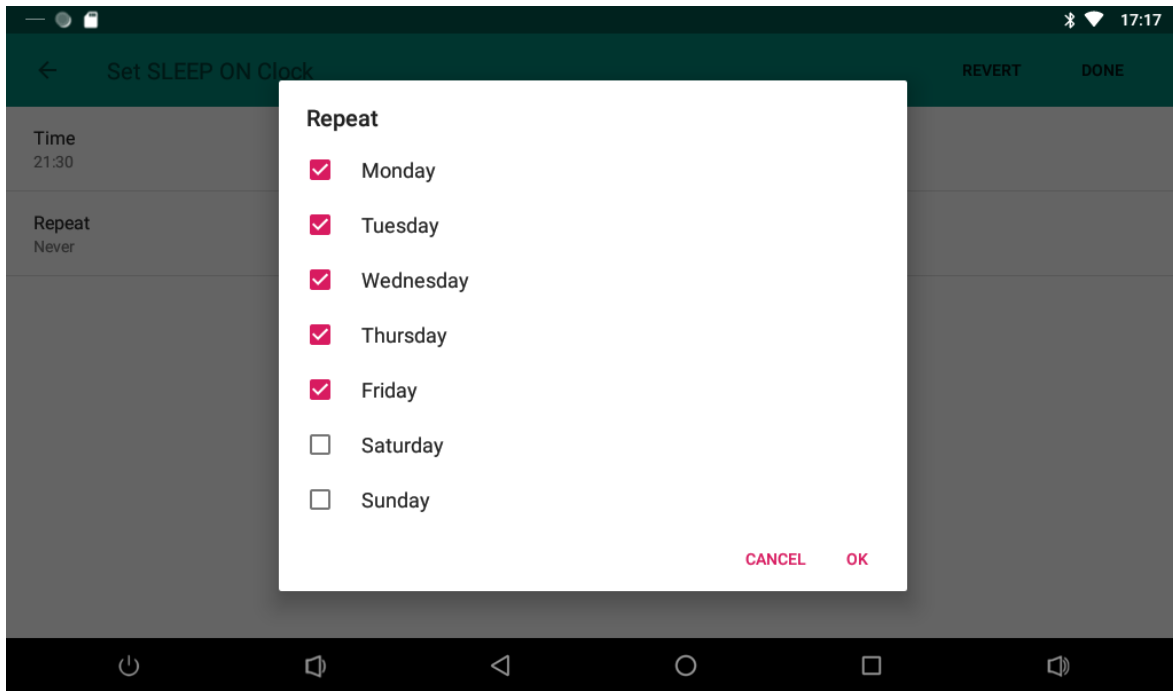

After setting, click **Done** at the upper-right corner of the screen to save them.

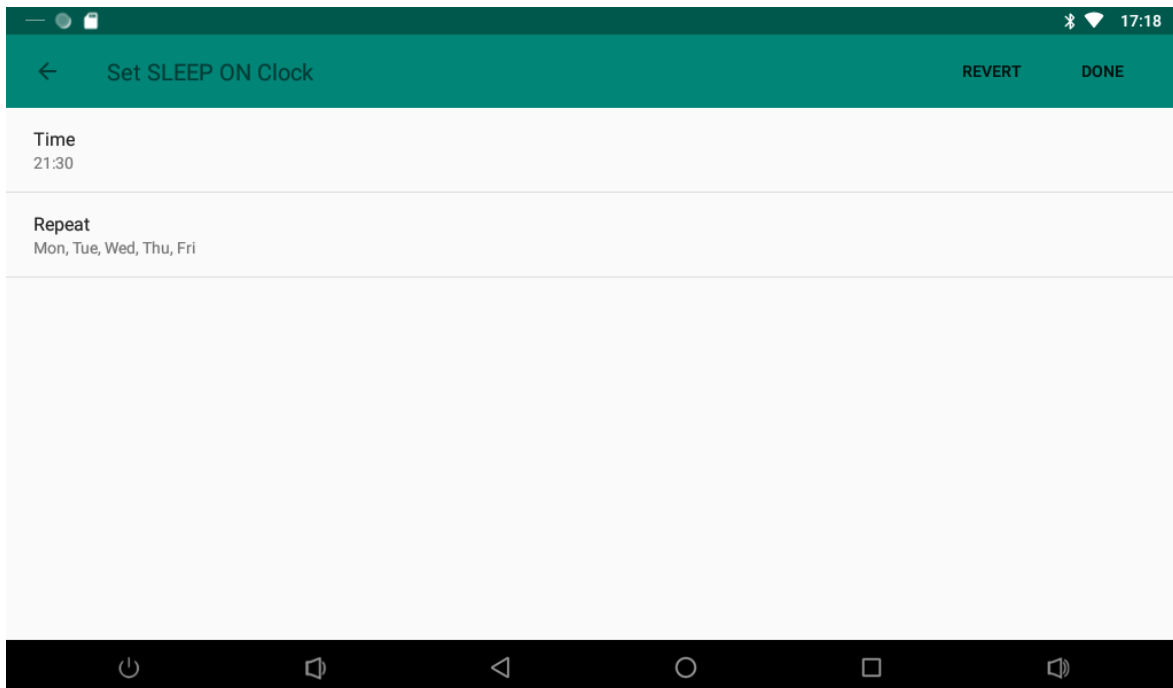

You will see the Sleep on option checked after saving the settings.

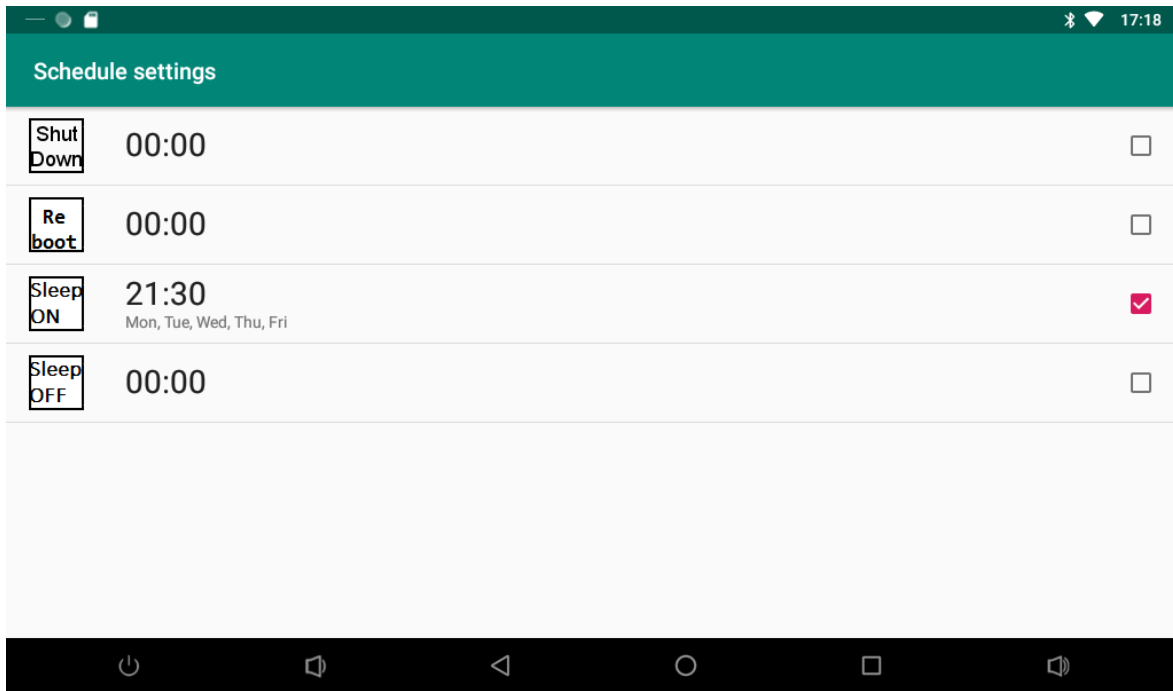

For sleep on clocks, you can set them as same as sleep off clocks.

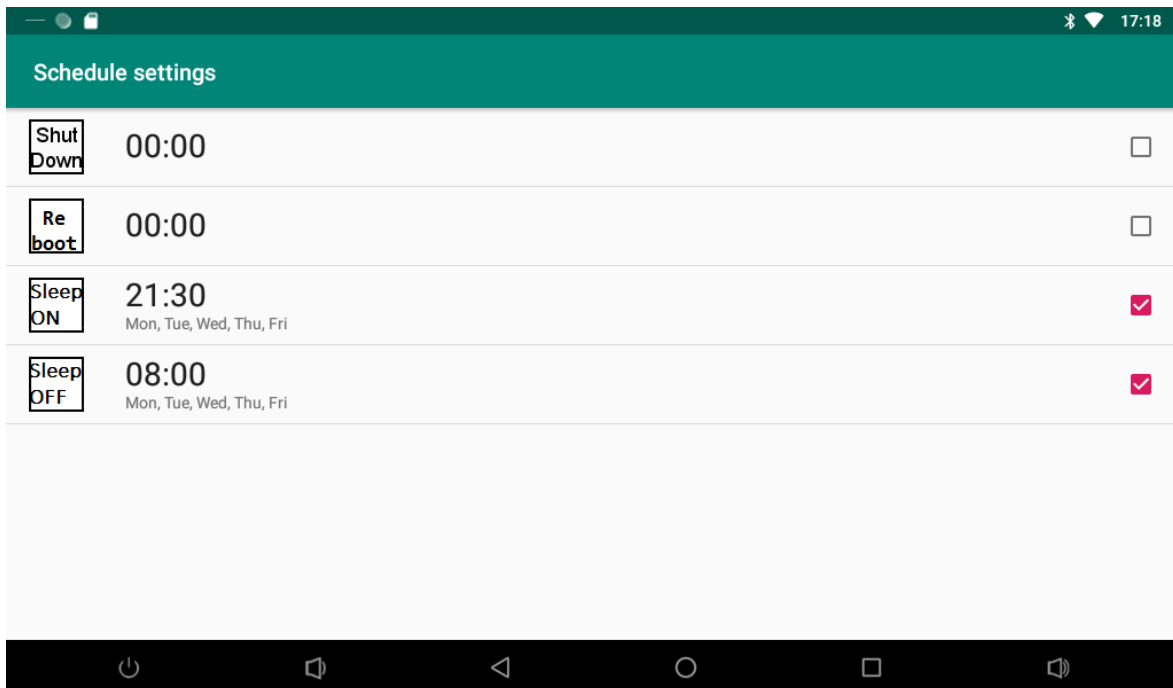

After the settings, the device will be powered off at set time, and powered on again when achieves the appointed time.

Wi-Fi

In the App list, click “**Settings**”  to open the system setting app, and select the option “**Wi-Fi**”.

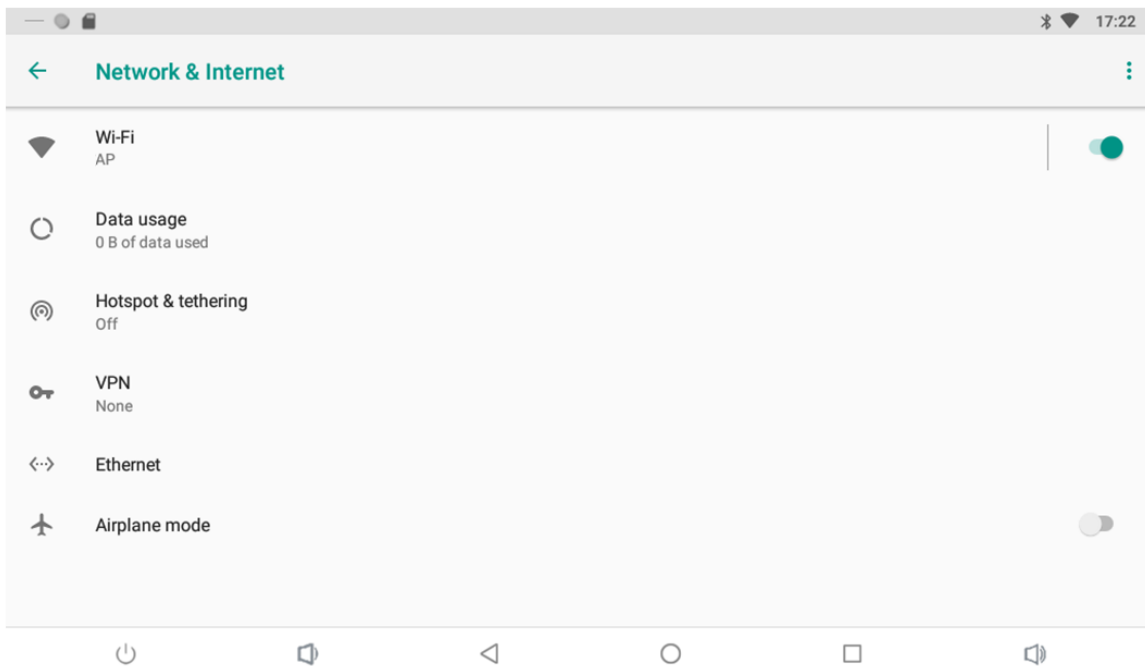

Switch the Wi-Fi button to **ON**. The product will scan available wireless networks automatically. Select a network under Wi-Fi networks and input the password to connect.

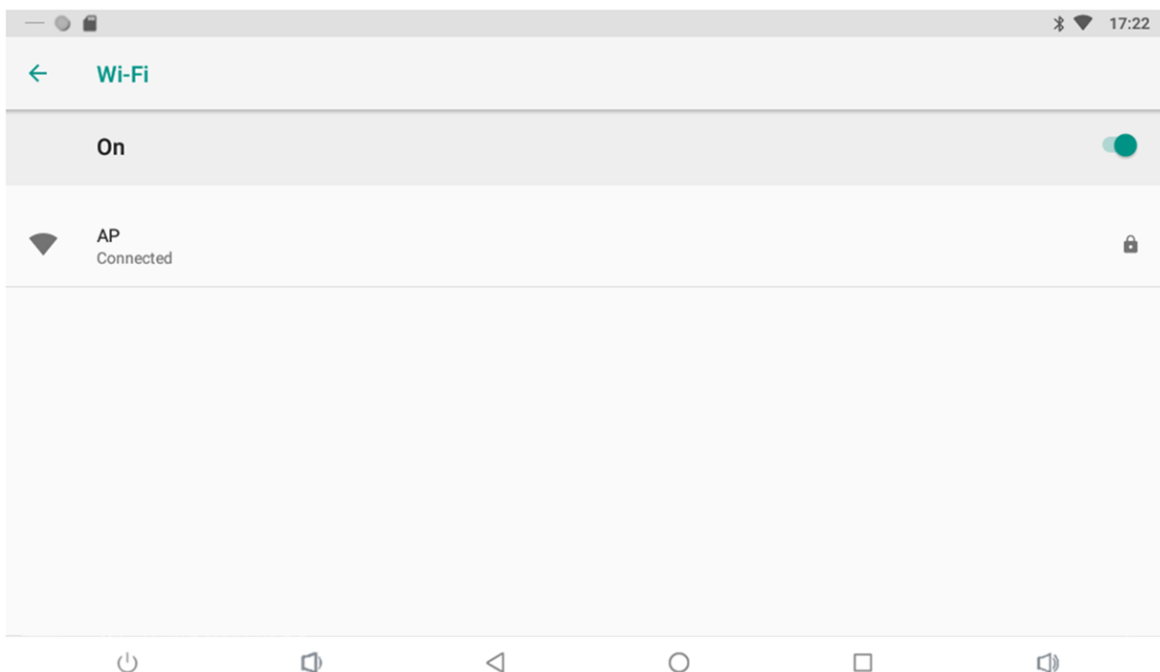

Ethernet

In the App list, click “**Settings**”  to open the “Network & internet”, select “**Ethernet**”.

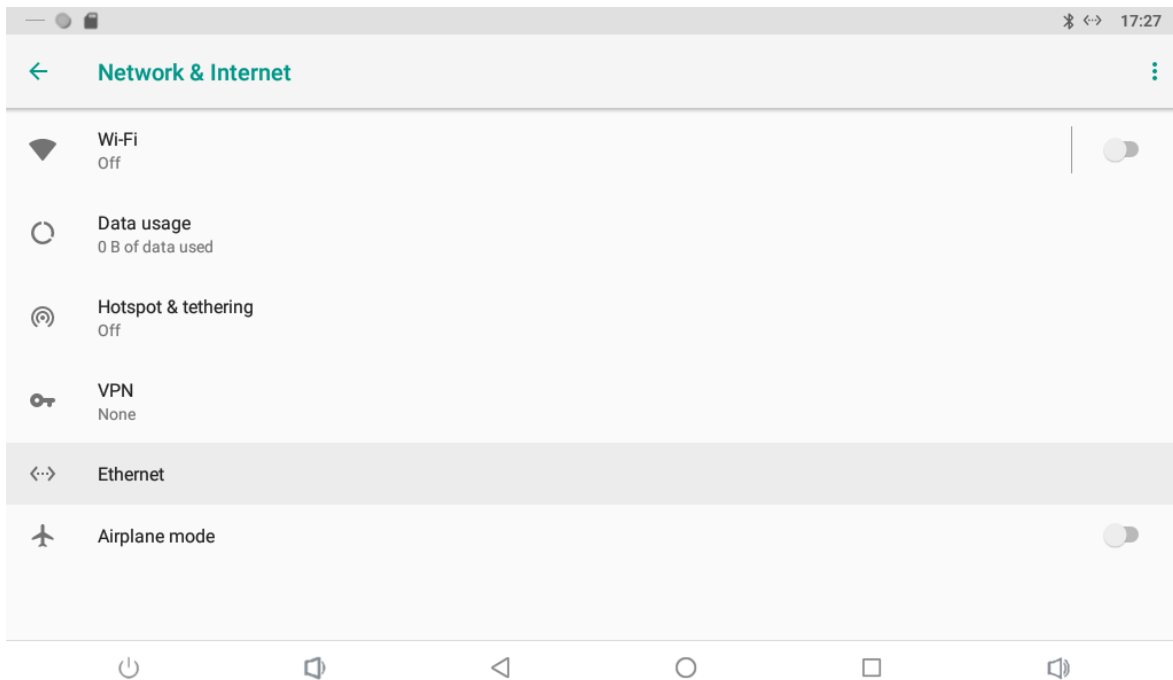

Check “Use Ethernet” and plug the Internet cable into the Ethernet port (**#9** in **Product Instruction**). If Wi-Fi is on, please turn off Wi-Fi to allow Ethernet working.

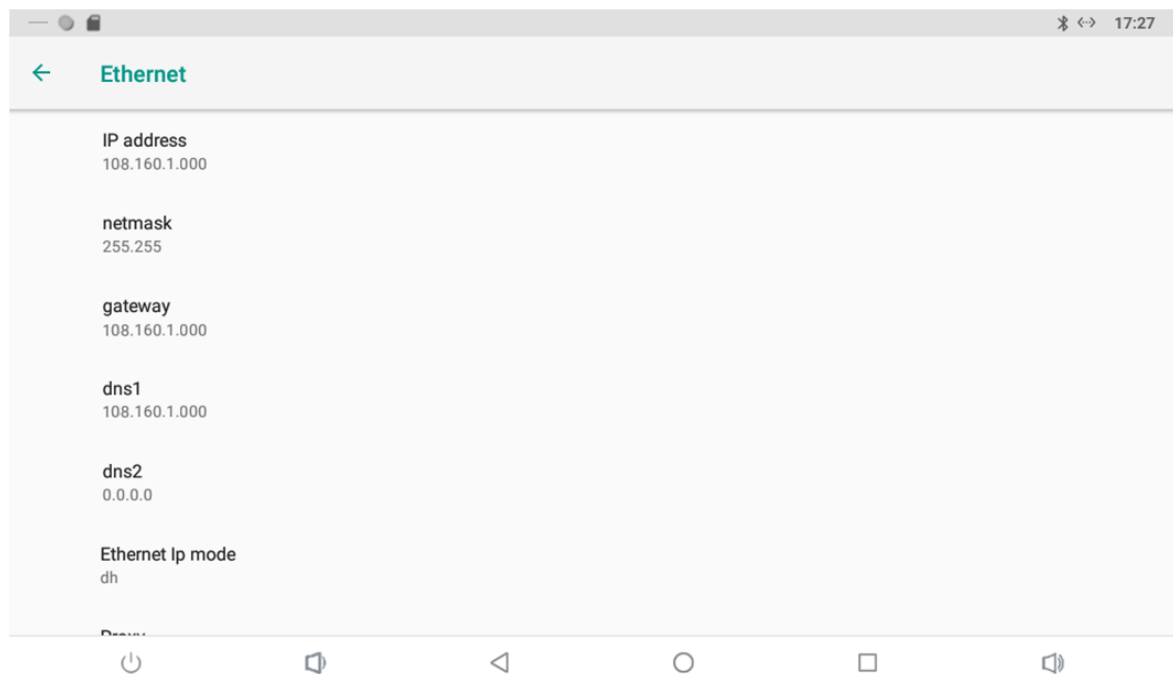

If you are Static IP user, please set the configurations manually.

Bluetooth

In the App list, click “Settings”  to open the system setting app;

Select the “Connection devices” option.

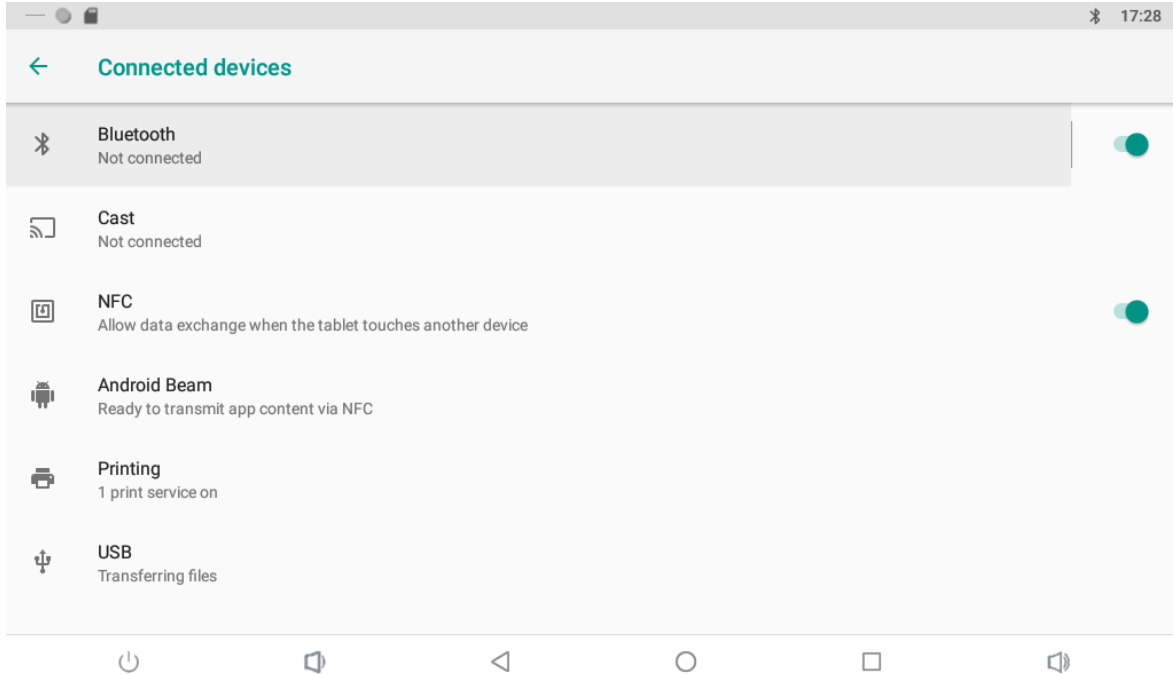

Switch the Bluetooth button to ON. Click “Pair new device” to view the product automatically scan around the available Bluetooth devices.

If you want to pair another Bluetooth device, select it from the “Available Devices” list, and then click “Pair” in the pop-up window. At the same time, click “Pair” in the pop-up window of the

Bluetooth device to be paired.

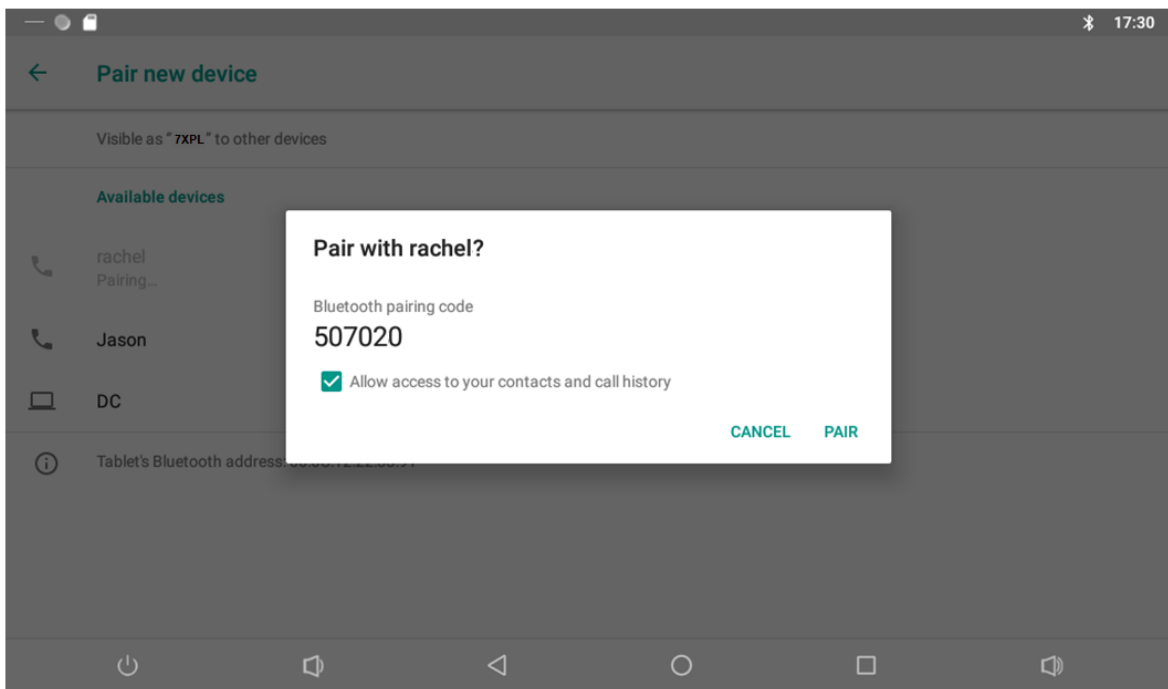

After pairing, the paired devices are displayed in the "paired devices" list.

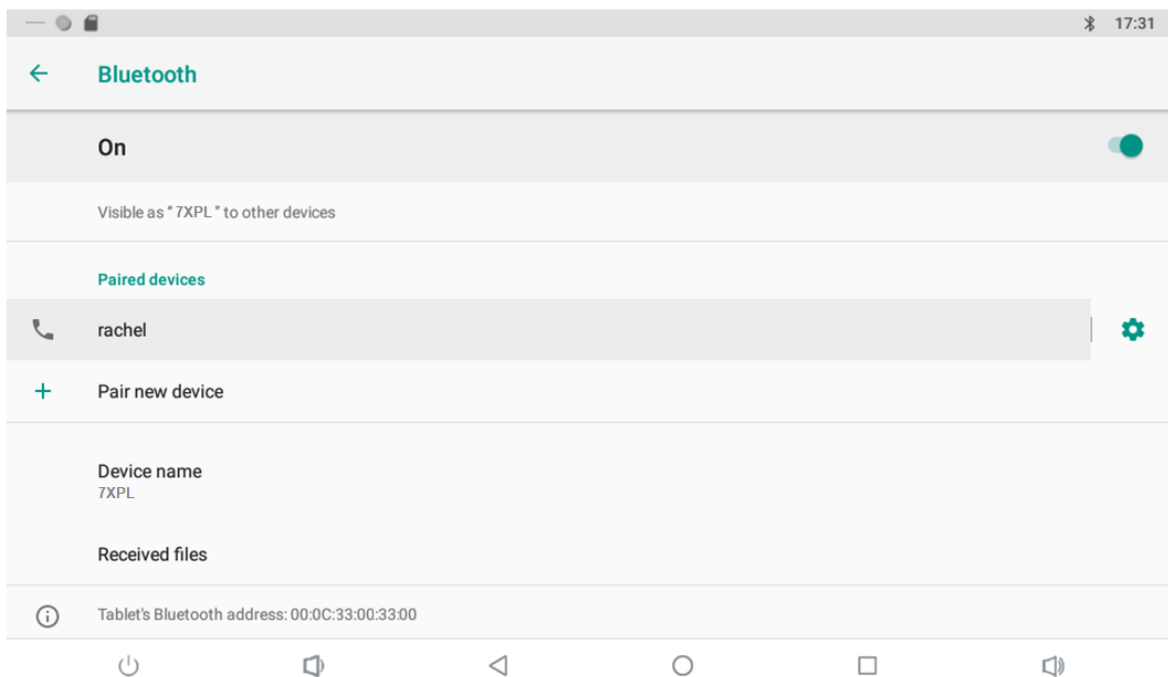

Click "Device name" to rename.

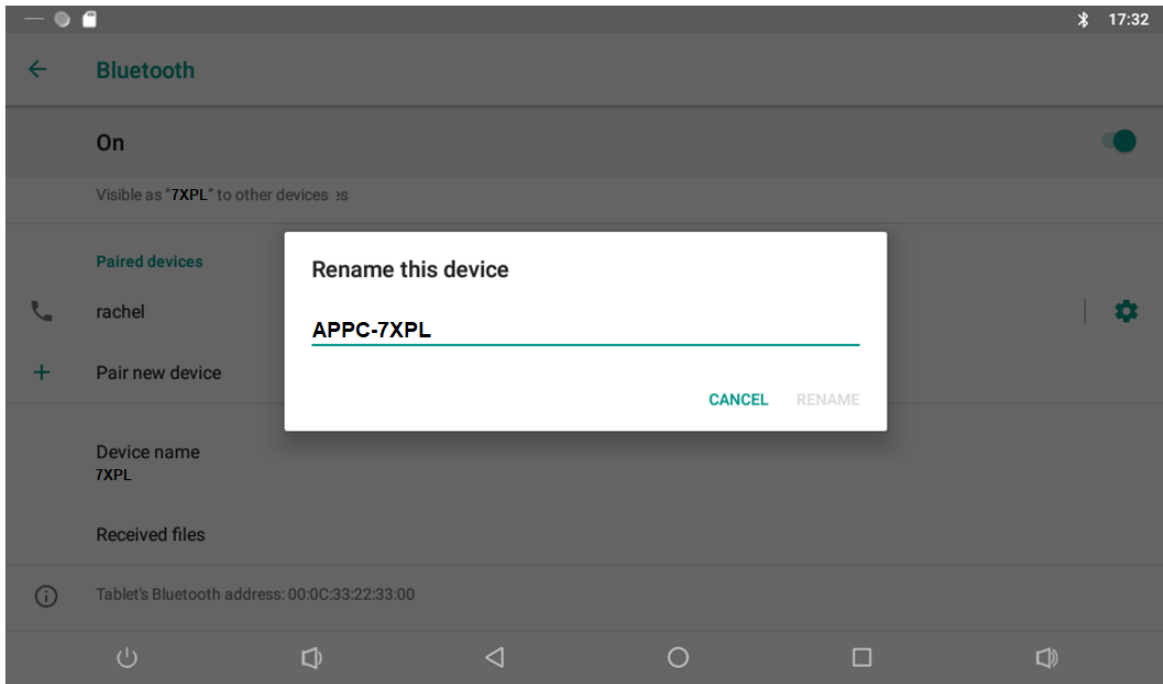

Virtual Keyboard

The device provides a virtual keyboard for typing. You can use it as a real one.

When you click in a text input box, the virtual keyboard will appear at the bottom of the screen.

To collapse the virtual keyboard, you can click the icon  in the system bar.

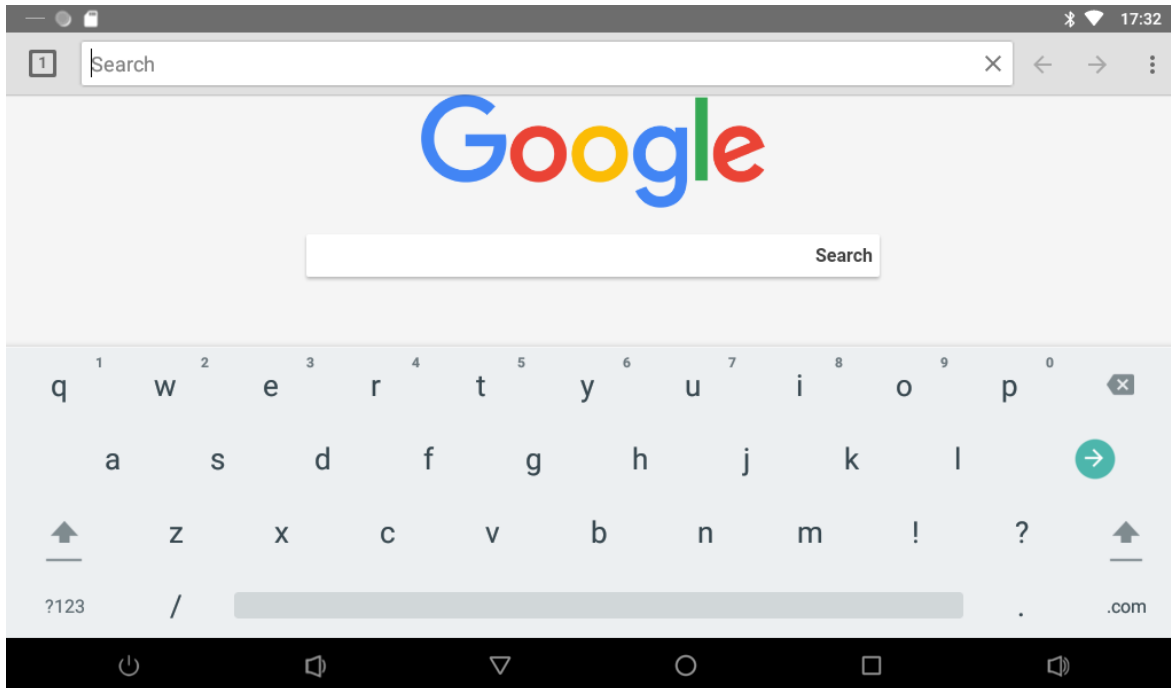

Switch Input Methods

Please check whether the installed input method is selected in the “**Language & input**” option under the system setting app.

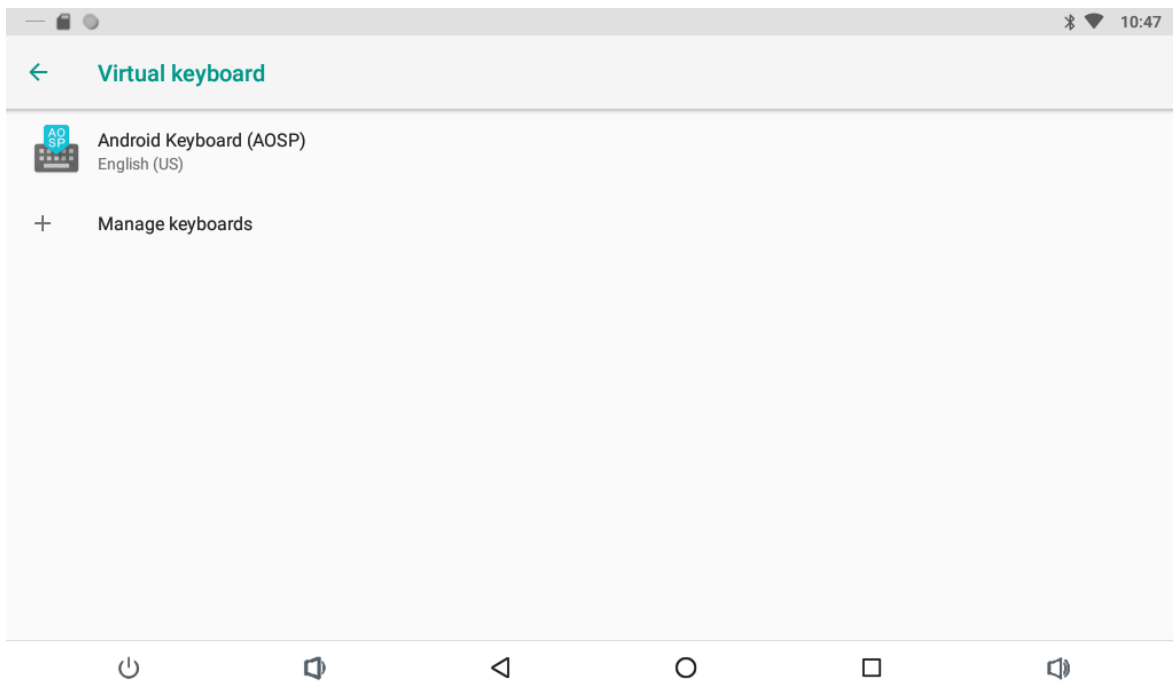

Surf Online

In the App list, open “**Browser**” .

When connecting the device to a network, you can visit websites, play online media or download files via the browser.

In a browser window, enter in a URL in the address bar and click “-->” in the virtual keyboard to go.

You can also click  to add new tabs to make multiple tabs opened simultaneously.

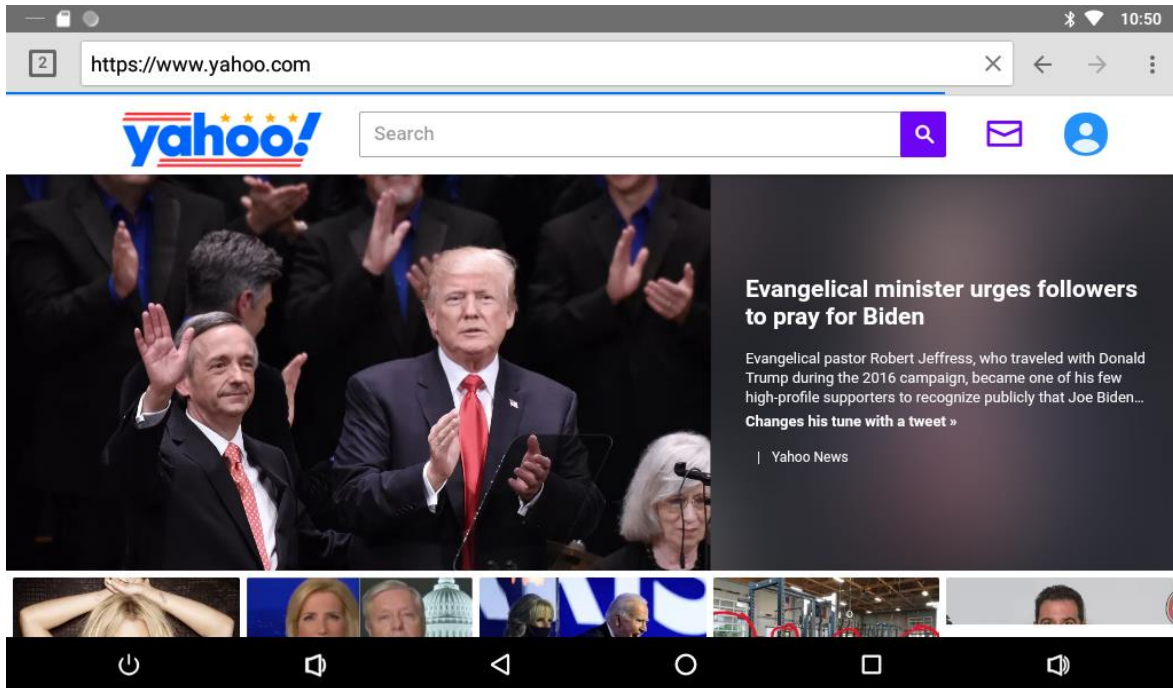

Browse Files

In the App list, open “**Explorer**”  to view local files.

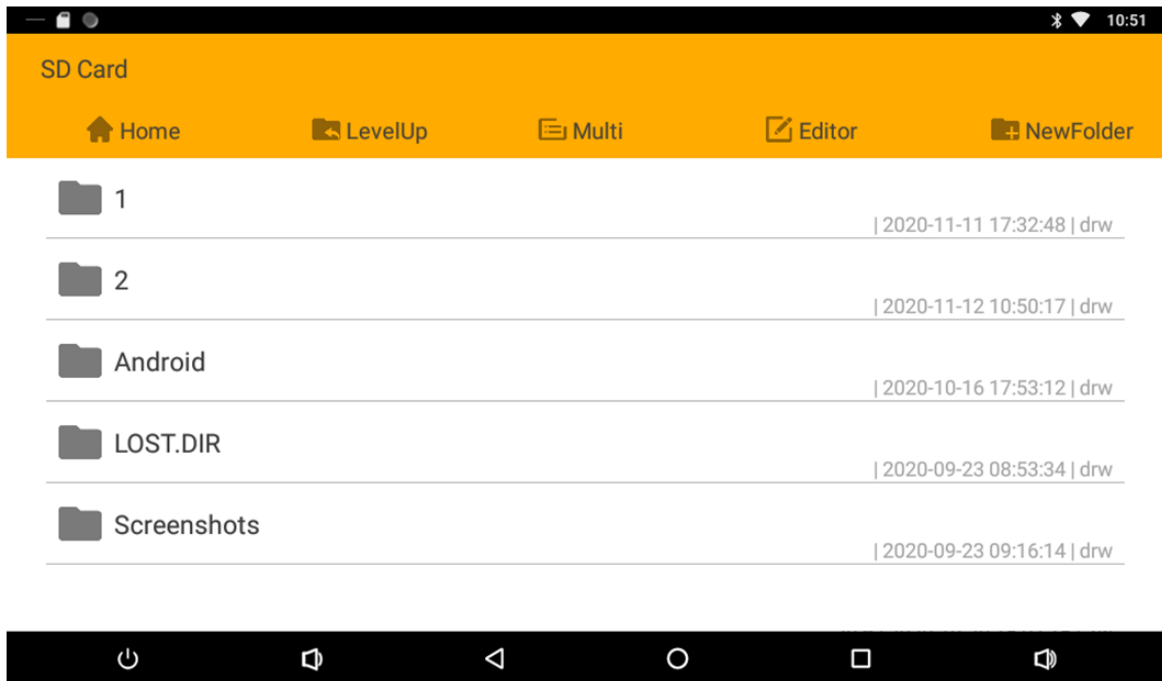

Long-press a file or folder to do file operations, such as copy, delete, move (cut), paste, rename, send (share) and create shortcut.

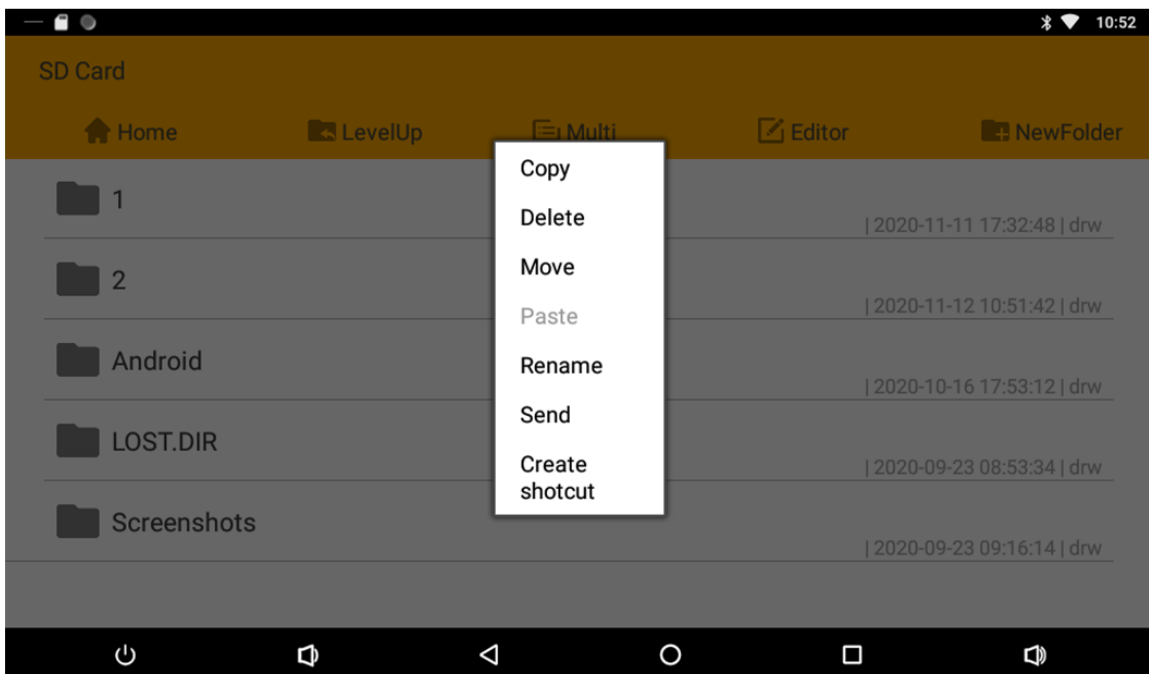

If you want to select several files/folders at once, click “Multi” in the menu, and then select files/folders. The selected files/folders will be highlighted in blue.

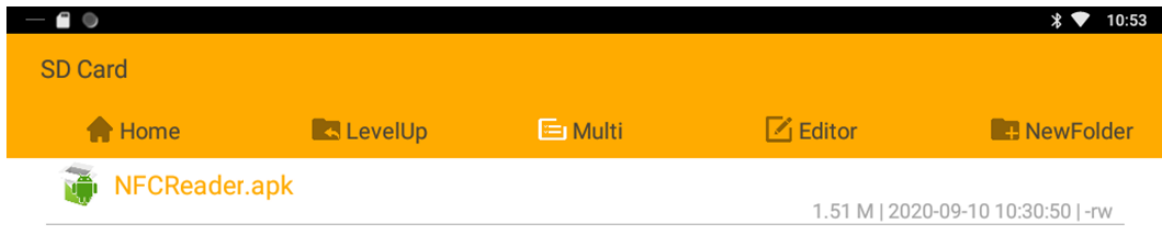

Click “Editor” in the menu to operate the selected files/folders.

Play Media

With the provided apps, you can play your media files on your storage, such as pictures, music and videos.



Picture Player:

Support JPG, BMP, GIF, JPEG, PNG.



Music Player:

Support MP1, MP2, WMA, WAV, AAC, OGG, APE, FLAC.



Video Player:

Support MKV, TS, FLV, AVI, VOB, MPG, DAT, ASF, RM, MOV, 3GP, MP4, WMV.

Install & Uninstall Apps

Install Apps

Before installing an app, please download the app (.apk) to via the browser, or copy a downloaded app to the device from your computer.

Then you can open “**ApkInstaller**”  in the App list to install the downloaded app.

Click “Install” button.

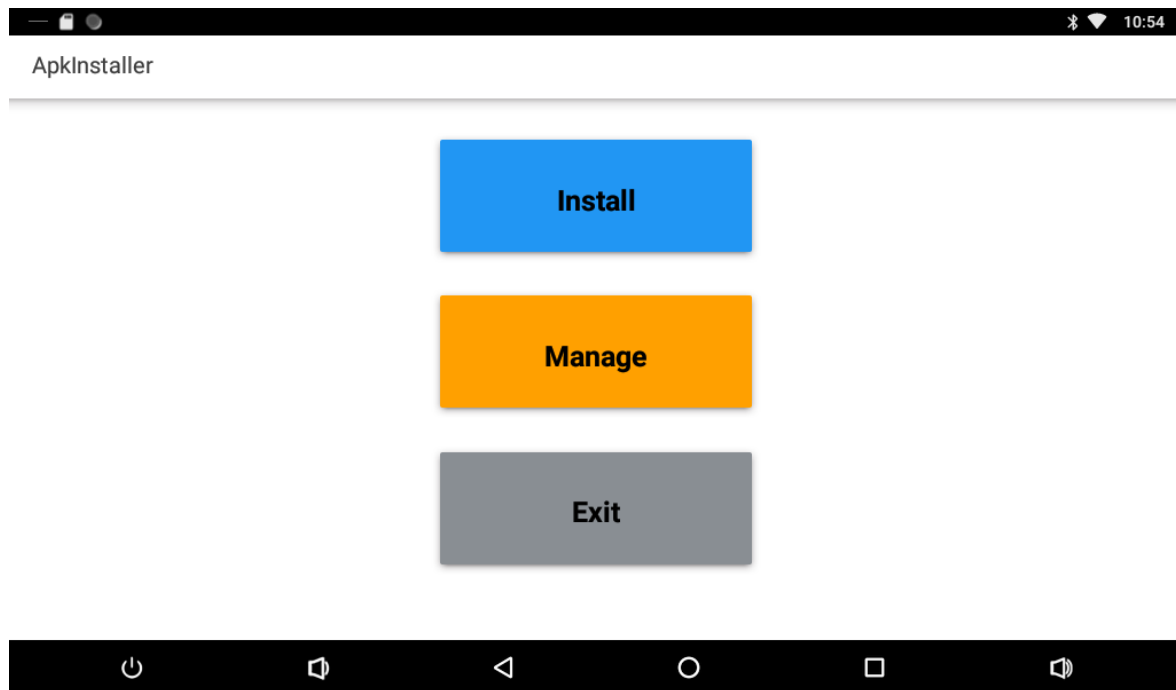

Choose the installation file's location.



The apk files will be automatically scanned in the right side list.

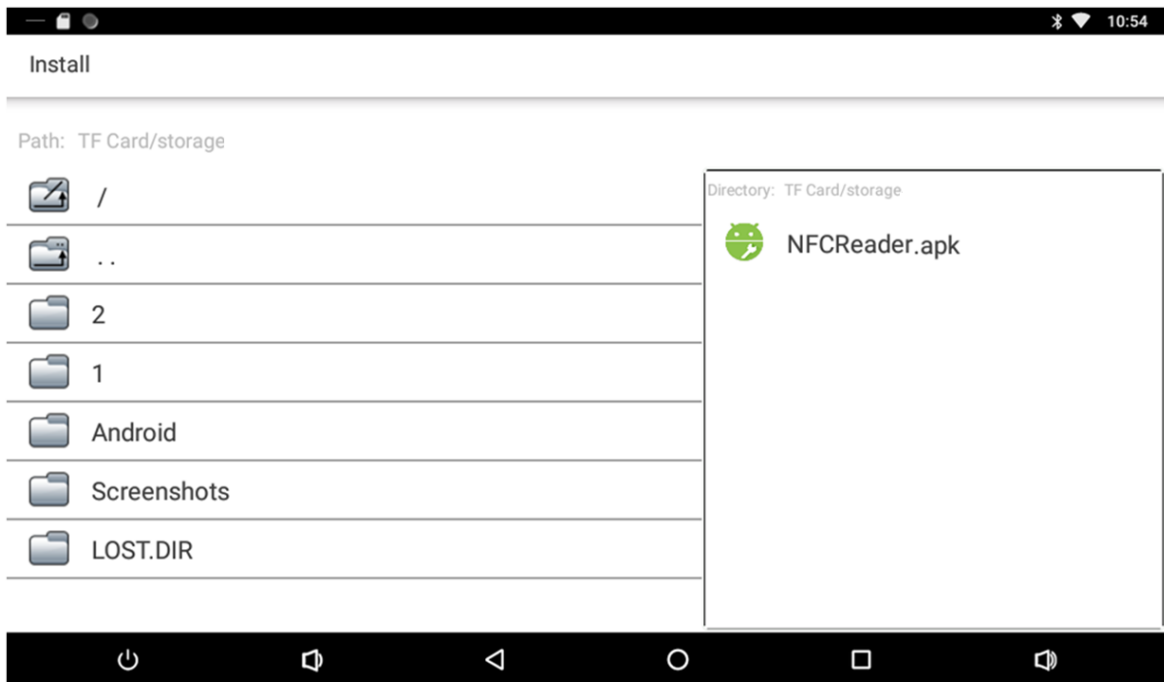

Click the apk you want to install.

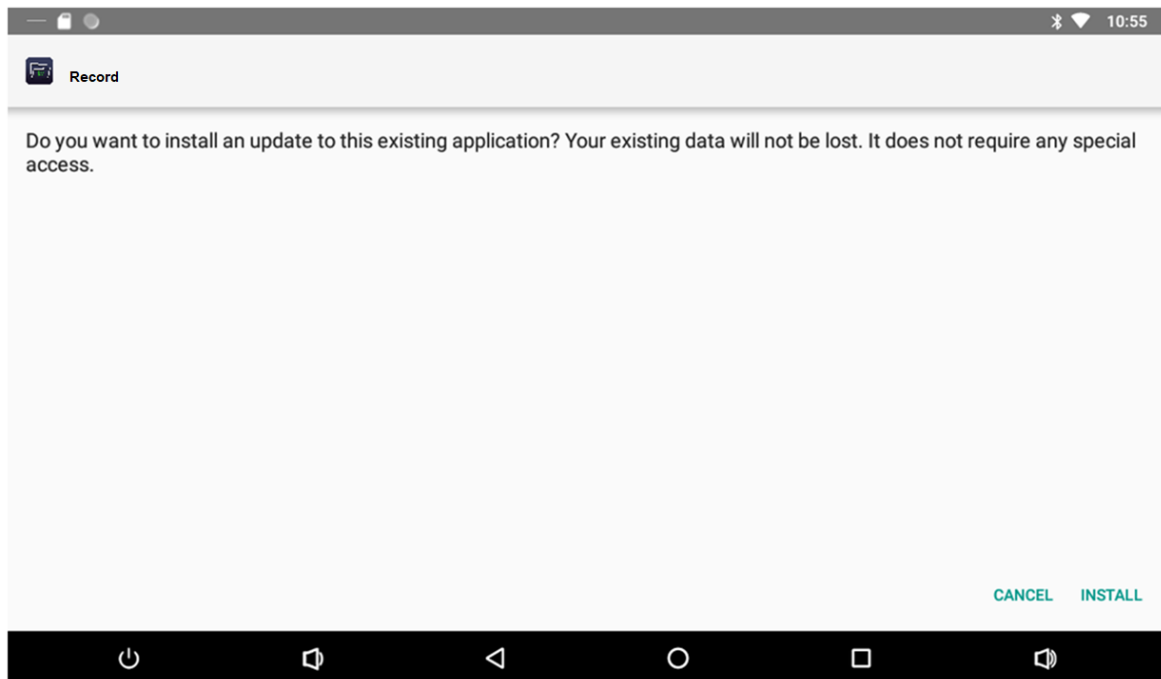

Click "Install" and then waiting for installation finished.

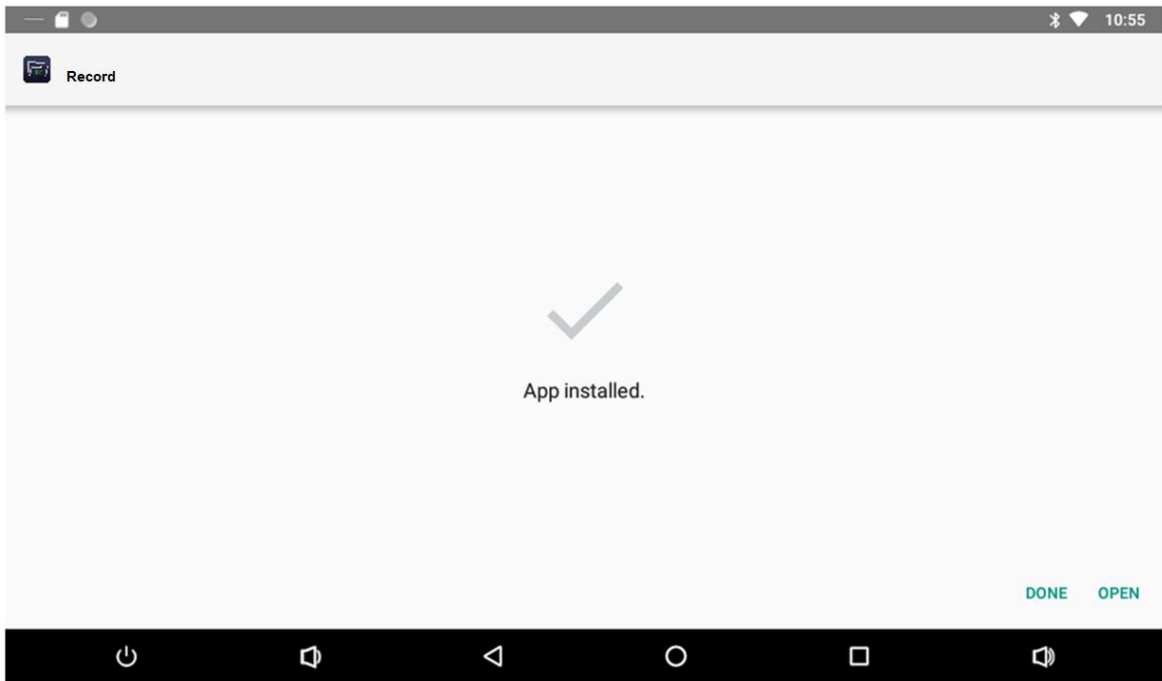

You can also download an android app market, and install the apps via the market.

If you encounter the following prompts, select "Setting" to enter " Install unknown apps" page".

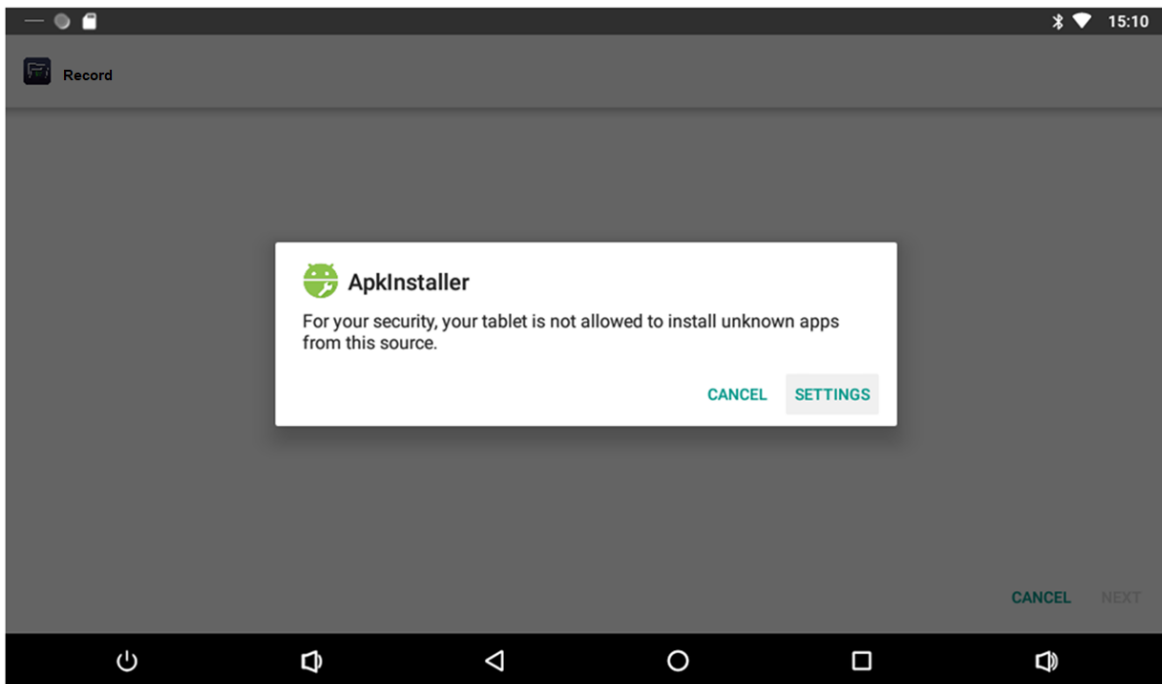

Turn on “Allow from this source” button, click the back icon to continue to install app.

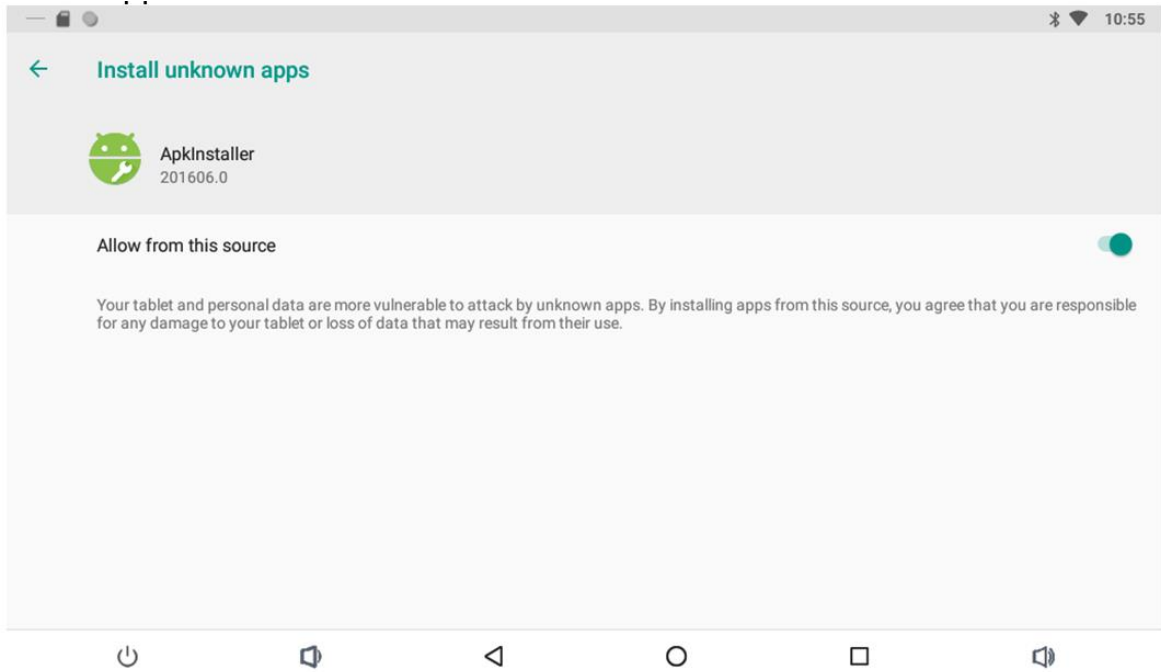

Uninstall Apps

To uninstall the app, go to the "Settings"-> "App&Notifications" list. In this option, you will see a list of installed applications.



Click the app you want to remove to enter the detail page.

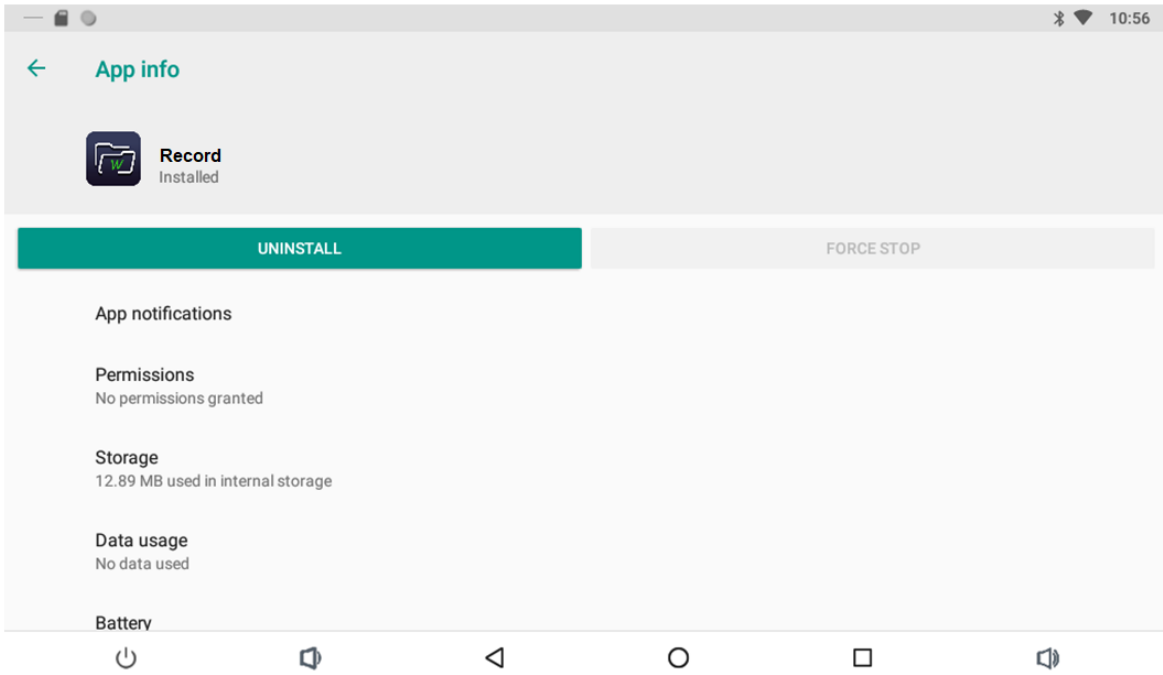

Click the “**Uninstall**” button and select “OK”, and then waiting for uninstallation finished.

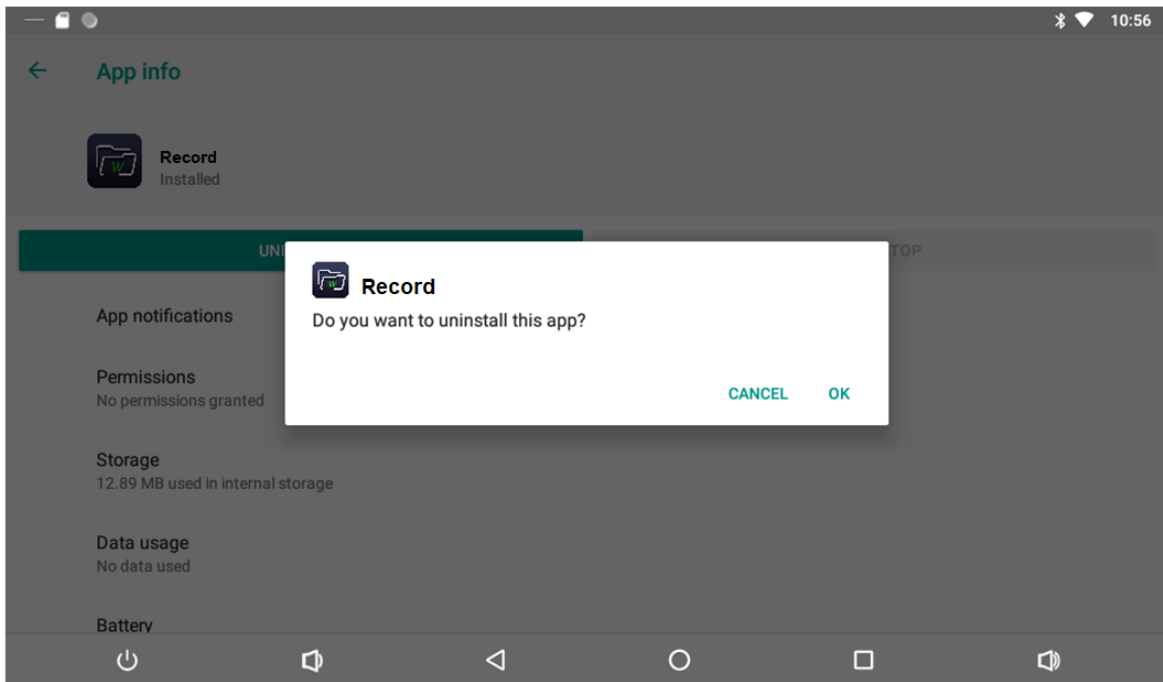

Reset to Factory Default

Please make sure to back up the important data before resetting the device.

In the App list, click “**Settings**”  to open the system setting app, and select the option “**Reset options**”.

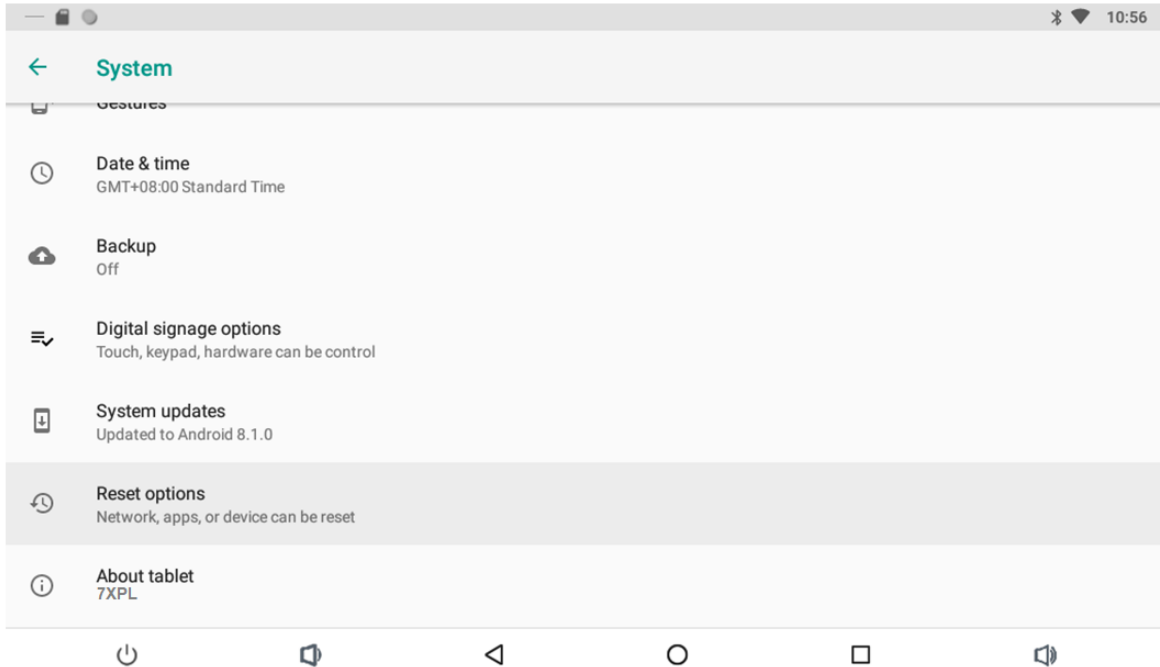

Select the option “**Erase all data(factory reset)**”.

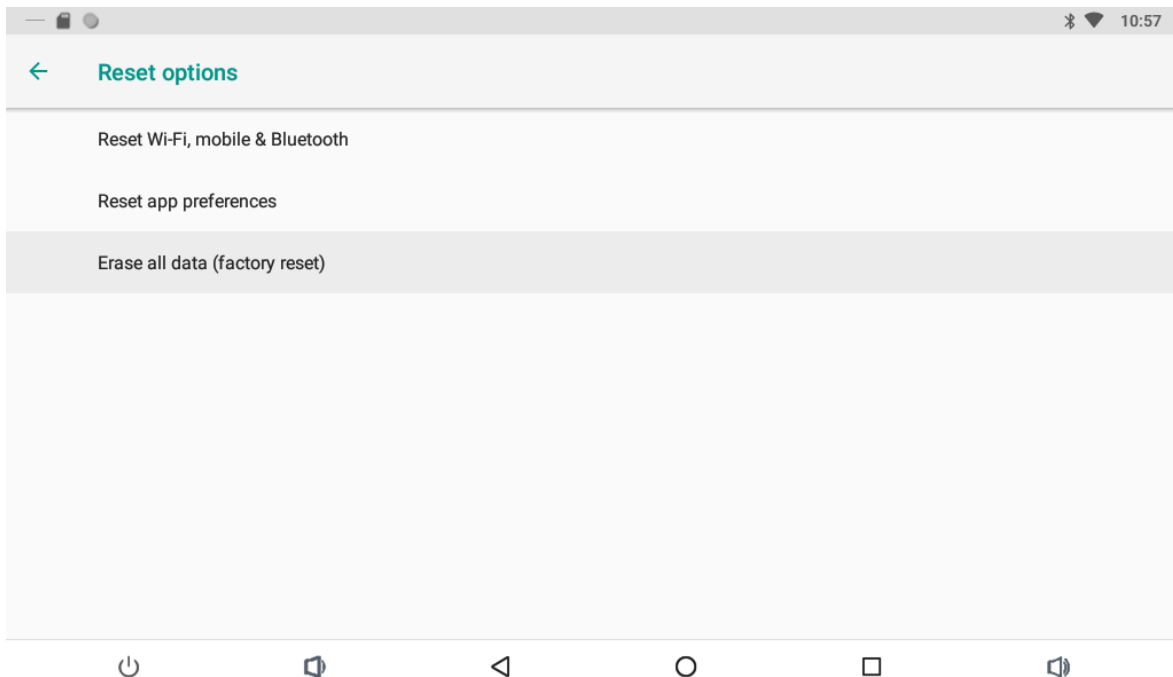

Click “RESET TABLET”.

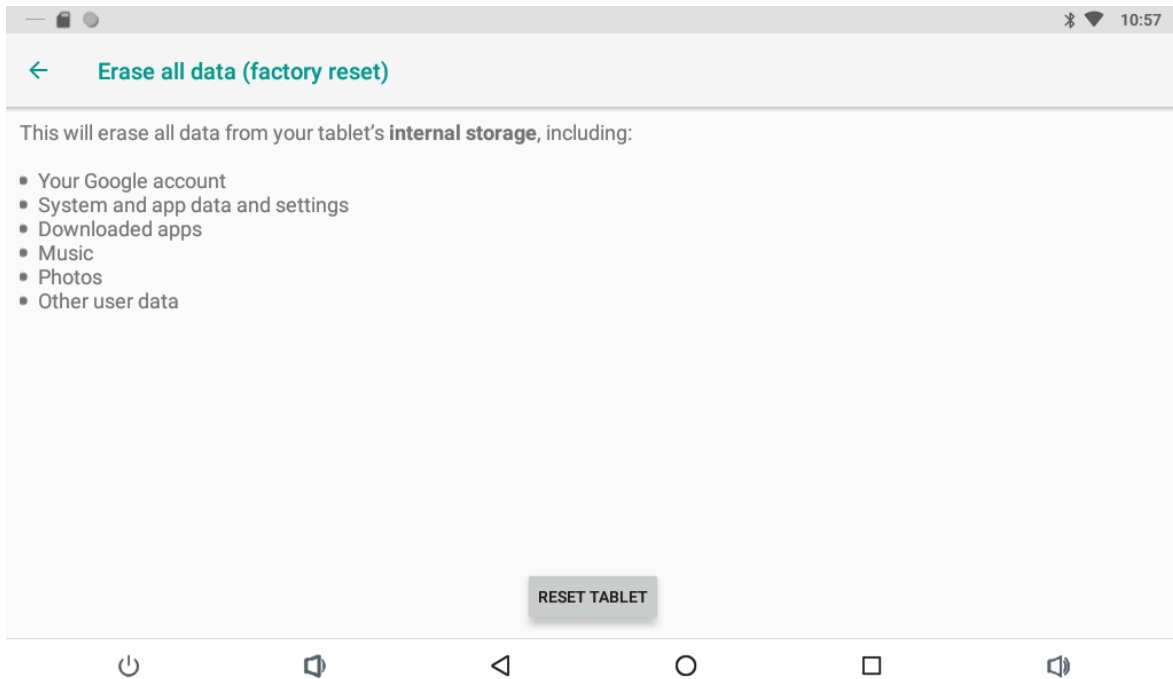

Click “Erase everything” button, and then waiting system reboots and resets to factory default.

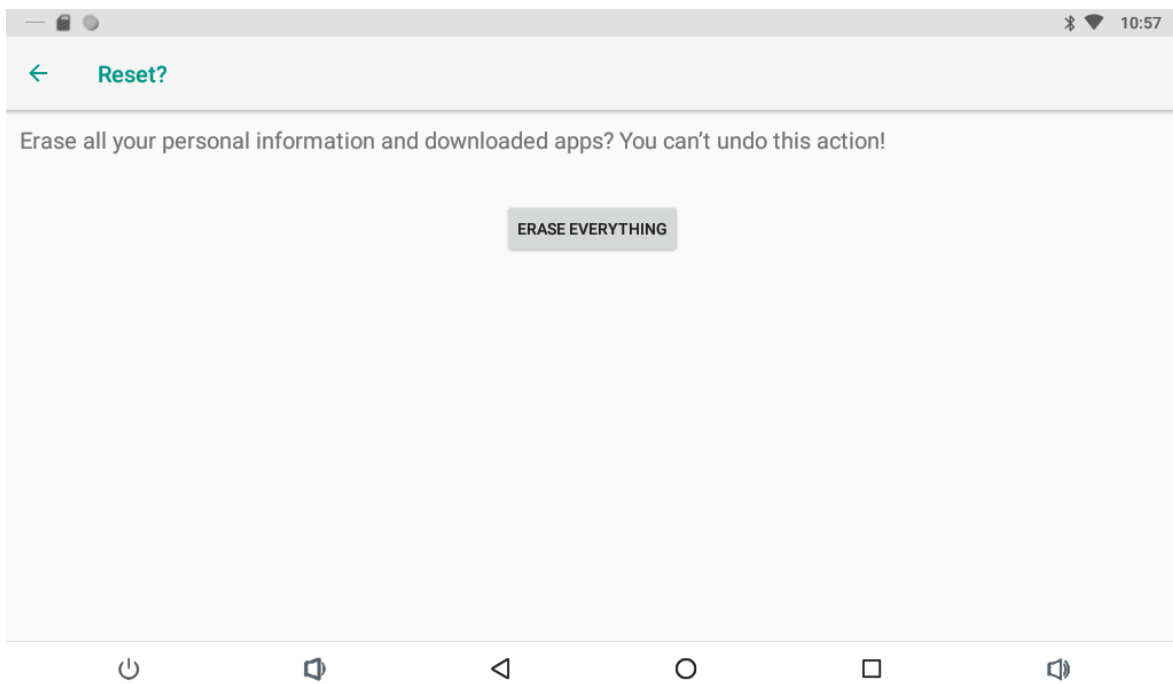

Federal Communications Commission (FCC) Statement

15.21 You are cautioned that changes or modifications not expressly approved by the part responsible for compliance could void the user's authority to operate the equipment.

15.105(b) This equipment has been tested and found to comply with the limits for a Class B digital device, pursuant to part 15 of the FCC rules. These limits are designed to provide reasonable protection against harmful interference in a residential installation. This equipment generates, uses and can radiate radio frequency energy and, if not installed and used in accordance with the instructions, may cause harmful interference to radio communications.

However, there is no guarantee that interference will not occur in a particular installation. If this equipment does cause harmful interference to radio or television reception, which can be determined by turning the equipment off and on, the user is encouraged to try to correct the interference by one or more of the following measures:

- Reorient or relocate the receiving antenna.
- Increase the separation between the equipment and receiver.
- Connect the equipment into an outlet on a circuit different from that to which the receiver is connected.
- Consult the dealer or an experienced radio/TV technician for help.

This device complies with Part 15 of the FCC Rules. Operation is subject to the following two conditions:

1. this device may not cause harmful interference, and
2. this device must accept any interference received, including interference that may cause undesired operation of the device.

FCC RF Radiation Exposure Statement: This equipment complies with FCC radiation exposure limits set forth for an uncontrolled environment.

This equipment should be installed and operated with minimum distance 20cm between the radiator & your body.

This transmitter must not be co-located or operating in conjunction with any other antenna or transmitter.

Operations in the 5.15-5.25GHz band are restricted to indoor usage only.

This device meets all the other requirements specified in Part 15E, Section 15.407 of the FCC Rule